

Power System Restoration Index for Load Frequency Control Assessment Using Artificial Bee Colony Algorithm in a Two-Area Reheat Interconnected Power System Co-ordinated with SMES Units

R . Jayanthi, I.A.Chidambaram

Abstract— This paper proposes evaluation of Restoration Indices for the Load-Frequency Control assessment of a Two-Area Two Unit Interconnected Power System (TATURIPS) coordinated with Superconducting Magnetic Energy Storage (SMES) units. As Proportional Integral (PI) type controller is still widely used for the solution of the Load Frequency Control (LFC) problem, in this paper also PI controllers are used. The optimal gain tuning of PI controllers for various case studies for the LFC problem is proposed and obtained using Artificial Bee Colony (ABC) algorithm. These controllers are designed and implemented in a TATURIPS coordinated without and with SMES units. The system was simulated and the frequency deviations, tie-line power deviation, control input deviations and additional mechanical power generation required for step load disturbance of 0.01 p.u.MW and 0.04 p.u.MW without and with outage condition in area-1 are presented. The simulation results and the evaluation of the Restoration Indices shows that the TATURIPS coordinated with SMES units ensures a better transient and steady state response and improved Restoration Indices than that of TATURIPS without SMES Units.

Index Terms— Load Frequency Control (LFC), Proportional Integral (PI) Controller, Super Conducting Magnetic Energy Storage (SMES) device, Restoration Index (RI).

I. INTRODUCTION

A major problem in the parallel operation of interconnected power systems is the control of frequency and inter-area tie-line power flow, termed as Load Frequency Control (LFC) problem. Deviations in these quantities arise due to unpredictable load variations which cause mismatch between the generated and demand powers. To ensure the quality of the power supply, a load-frequency control is required to minimize the transient deviations and ensure zero steady state errors of these two variables.

R.JAYANTHI, Department of Electrical Engineering, Faculty of Engineering and Technology, Annamalai University, Annamalai Nagar,Chidambaram-608002, Tamil Nadu, India. (e-mail: rrjay_pavi@yahoo.co.in).

Dr. I. A. CHIDAMBARAM, Department of Electrical Engineering, Faculty of Engineering and Technology, Annamalai University, Annamalai Nagar,Chidambaram-608002, Tamil Nadu, India. (e-mail: driacdm@yahoo.com).

Modern power system consists of number of control areas interconnected together and power is exchanged between control areas over tie-lines by which they are connected. LFC plays a significant role in the power system by maintaining scheduled system frequency and tie-line flow during normal operating condition and also during small load perturbations [1], [2]. A severe stress in the system results in an imbalance between generation and load which seriously degrades the power system performance and requires considerable attention in the power system frequency control issues. The unsuppressed frequency deviation will deteriorate the performance of the equipment, degrading the performance of the transmission line capacities and can interfere with the system protection leading to an unstable condition of power system. Frequency oscillations may experience a severe stability problem in power systems which occurs as a consequence of uncertainties. In order to have a stable operating condition, the system is to be restored to a normal working range. Also, the frequency problem is defined in terms of the resources availability under the fact that they provide adequate back-up during inter-area oscillations. In multi-area power systems besides maintaining the normal frequency, the problem of uncertainty in continuous electromechanical oscillations resulting in the tie-line power deviations due to the change in customer load demand. Many investigations in the interconnected power systems have been reported in the past [1]-[5].

The stability of the inter-area oscillation mode is deteriorated by the heavy load condition in tie-lines especially due to the electric power exchange. To solve this problem, superconducting magnetic energy storage (SMES), which is capable of controlling active and reactive power simultaneously, has been proposed as one of the most effective stabilizers of inter-area power oscillations. Superconducting energy storage systems (SMES) represent a fascinating prospective FACTS technology as they can generate / absorb active and reactive power in rapid response to power system requirements [6]. SMES systems are considered for a variety of applications in Load-Frequency Control, spinning reserve, peak generation and load shifting, improving stability and transmission efficiency. The superconducting magnetic energy storage system (SMES) being a fast acting device can swallow well these oscillations and help in reducing the frequency and tie-power deviations. For better performance achievement, the

use of nonlinear neural adaptive predictive control for active power modulation of SMES is proposed in this paper.

Classical approach based optimization for controller gains is a trial and error method and extremely time consuming when several parameters have to be optimized simultaneously and provides suboptimal result. Amongst the population based algorithms, Simulated Annealing (SA) suffers from setting of algorithm parameters and give rise to repeated revisiting of the same suboptimal solution. Genetic Algorithm (GA) is faster than SA as GA has parallel search. The premature convergence in the combined GA / Particle Swarm Optimization (PSO) methods degrades its search capability. Although, these methods seem to be expert methods for the solution of decentralized controller's parameter optimization problem, when the system has an objective function where parameters being optimized are highly correlated, and number of parameters to be optimized is large, then they have degraded efficiency to obtain global optimum solution. In order to overcome these drawbacks, an Artificial Bee Colony (ABC) algorithm based PI type controller is proposed for the solution of the LFC problem in this paper. Here, ABC optimization algorithm is used for optimal tuning of PI parameter to improve optimization synthesis and damping of frequency oscillations. To damp out these critical oscillations due to frequency excursions, for the system under study a Two-Area Two-Unit Reheat Interconnected thermal Power System with SMES on both the areas is considered and with the optimization algorithm ABC the tuning of PI controller parameters are obtained and used for the power Restoration Indices (RI) computation. Various case studies are analysed to develop Restoration Indices namely, Feasible Restoration Index (FRI) and Complete Restoration Index (CRI) which are able to predict the normal operating mode, emergency mode and restorative modes of the power system.

II. MODELING OF A TWO-AREA INTERCONNECTED THERMAL REHEAT POWER SYSTEM

A two-area two-unit reheat interconnected power system with SMES units is considered for the study as shown in figure 1. The detailed block diagram is given in figure 2 and the system data is provided in the appendix. Under normal operating conditions a power system is continually subjected to small random-like disturbances, requires adequate change in scheduled generation of the system. This transient of a power system following a disturbance is generally oscillatory in nature, which results in momentary oscillations in power flow in the transmission system [3, 4]. The generation changes must be made to match the load perturbation at the nominal conditions, if the normal state is to be maintained. The mismatch in the real power balance affects primarily the system frequency but leaves the bus voltage magnitude essentially unaffected. In a power system, it is desirable to achieve better frequency constancy than obtained by the speed governing system alone [4]. This

requires that each area should take care of its own load changes, such that schedule tie power can be maintained. As the interconnected power system with two areas and two units contains SMES units in each of its area, improves transients and tie-line power deviations against small load perturbations. A two-area interconnected system dynamic model in state variable form can be conveniently obtained from the transfer function model. The state variable equation of the minimum realization model of the 'N' area interconnected power system is expressed as [5]

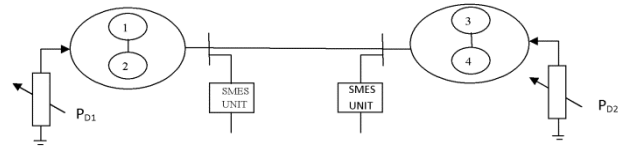

Fig. 1 TATURIPS with SMES

$$\dot{X} = Ax + Bu + \Gamma d \tag{1}$$

$$Y = Cx \tag{2}$$

Where, the system state vector x consists of the following variables as:

$$[x] = \left[\int ACE_1 dt, \int ACE_2 dt, \Delta F_1, \Delta P_{g1}, \Delta X_{e1}, \Delta P_{r1}, \Delta P_{tie}, \Delta F_2, \Delta P_{g2}, \Delta X_{e2}, \Delta P_{r2} \right]^T$$

$$u = [u_1, \dots, u_N]^T = [\Delta P_{e1}, \dots, \Delta P_{eN}]^T \quad N - \text{Control input vector}$$

$$d = [d_1, \dots, d_N]^T = [\Delta P_{D1}, \dots, \Delta P_{DN}]^T \quad N - \text{Disturbance input vector}$$

$$y = [y_1, \dots, y_N]^T \quad 2N - \text{measurable output vector} \tag{3}$$

A is system matrix, B is the input distribution matrix and Γ disturbance distribution matrix, x is the state vector, u is the control vector and d is the disturbance vector of load changes of appropriate dimensions. The typical values of system parameters for nominal operation condition are given in appendix. This study focuses on optimal tuning of controllers for LFC and tie-power control with settling time based optimization using Artificial Bee Colony (ABC) algorithm to ensure a better power system restoration assessment. The aim of the optimization is to search for the optimum controller parameter setting that maximizes the minimum damping ratio of the system. On the other hand in this study the goals are control of frequency and inter area tie-power with good oscillation damping and also obtaining a good performance under all operating conditions and various loads and finally designing a low-order controller for easy implementation.

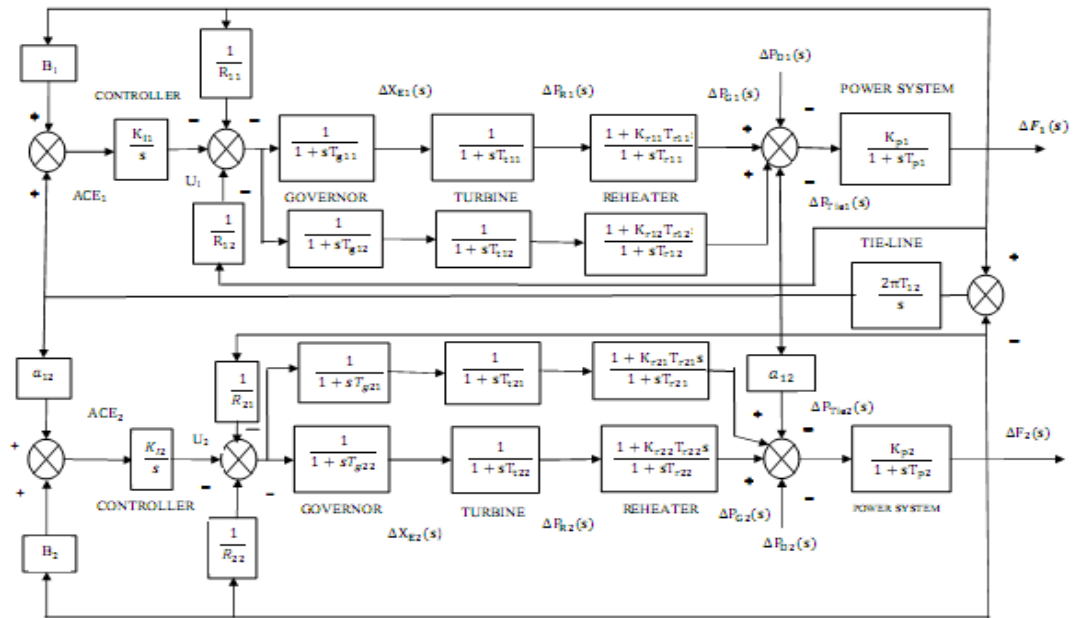

Fig. 2 Transfer function model of a TATURIPS

III. SMES UNIT

The schematic diagram in Fig. 3 shows the configuration of a thyristor controlled SMES unit. In the SMES unit, a DC magnetic coil is connected to the AC grid through a Power Conversion System (PCS) which includes an inverter/rectifier. The superconducting coil can be charged to a set point from the utility grid during normal operation of the power system. Once the superconducting coil gets charged, it conducts current virtually without any loss [6, 7]. When there is a change in the load demand (increase), the stored energy is almost released through the PCS to the power system as alternating current. As the governor and other control mechanisms start working to their set values, the coil current changes back to its initial value of current. Similar action occurs during sudden release of loads (i.e) the coil immediately gets charged towards its full value, thereby absorbing the excess energy in the system and once the system returns to its steady state, the excess energy absorbed is released and the coil current come back to its normal value. The control of the converter firing angle provides the DC voltage appearing across the inductor to be continuously varying within a certain range of positive and negative values. The SMES unit contains DC superconducting Coil and converter which is connected by Y-D/Y-Y transformer. The inductor is initially charged to its rated current I_{d0} by applying a small positive voltage. Once the current reaches the rated value, it is maintained constant by reducing the voltage across the inductor to zero since the coil is superconducting. Neglecting the transformer and the converter losses, the DC voltage is given by

$$E_d = 2V_{d0} \cos \alpha - 2I_d R_c \quad (4)$$

Where E_d is DC voltage applied to the inductor, firing angle (α), I_d is current flowing through the inductor. R_c is

equivalent commutating resistance and V_{d0} is maximum circuit bridge voltage. Charge and discharge of SMES unit are controlled through change of commutation angle α . In AGC operation, the dc voltage E_d across the superconducting inductor is continuously controlled depending on the sensed area control error (ACE) signal. Moreover, the inductor current deviation is used as a negative feedback signal in the SMES control loop. So, the current variable of SMES unit is intended to be settling to its steady state value. If the load is used as a negative feedback signal in the SMES control demand changes suddenly, the feedback provides the prompt restoration of current. The inductor current must be restored to its nominal value quickly after a system disturbance, so that it can respond to the next load disturbance immediately [8, 9]. As a result, the energy stored at any instant is given by

$$W_{sm} = W_{smo} + \int_{t_0}^t P_{sm}(\tau) d\tau \quad (5)$$

Where,

$W_{smo} = 1/2 LI_{d0}^2$, initial energy in the inductor.

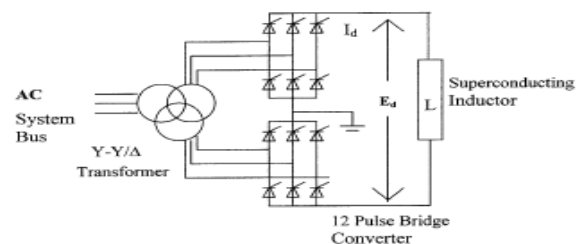

Fig. 3 Schematic diagram of SMES unit

Equations of inductor voltage deviation and current deviation for each area in Laplace domain are as follows

Power System Restoration Index for Load Frequency Control Assessment Using Artificial Bee Colony Algorithm in a Two-Area Reheat Interconnected Power System Co-ordinated with SMES Units

$$\Delta E_{di}(s) = \left(\frac{K_{SMES}}{1 + sT_{dci}} \right) [\beta_i \Delta F_i(s) + \Delta P_{tie1}(s)] - \frac{K_{id}}{1 + sT_{dci}} \Delta I_{di}(s) \quad (6)$$

$$\Delta I_{di}(s) = (1/sL_i) * \Delta E_{di}(s) \quad (7)$$

Where

$\Delta E_{di}(s)$ = converter voltage deviation applied to inductor in SMES unit

K_{SMES} = Gain of the control loop SMES

T_{dci} = converter time constant in SMES unit

K_{id} = gain for feedback ΔI_{di} in SMES unit.

$\Delta I_{di}(s)$ = inductor current deviation in SMES unit

The deviation in the inductor real power of SMES unit is expressed in time domain as follows

$$\Delta P_{SMESi} = \Delta E_{di} I_{doi} + \Delta I_{di} \Delta E_{di} \quad (8)$$

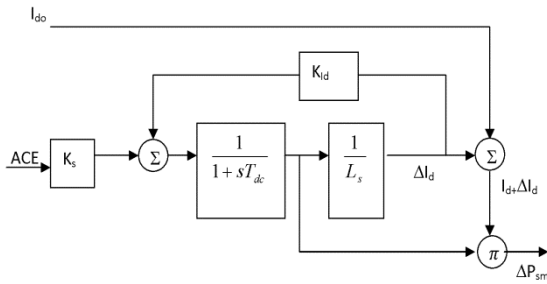

Fig. 4 Block diagram of SMES unit

Figure 4 shows the block diagram of the SMES unit. To achieve quick restoration of the current, the inductor current deviation can be sensed and used as a negative feed back signal in the SMES control loop. In a two-area interconnected thermal power system under study with the sudden small disturbances which continuously disturb the normal operation of power system. As a result the requirement of frequency controls of areas beyond the governor capabilities SMES is located in area1 absorbs and supply required power to compensate the load fluctuations.

Tie-line power flow monitoring is also required in order to avoid the blackout of the power system. The Input of the integral controller of each area is

$$ACE_i = \beta_i \Delta F_i + \Delta P_{tie i} \quad (9)$$

Generally the application of energy storages to electrical power system can be grouped into two categories i.e Storage meant for load leveling application and to improve the dynamic performance of power system. SMES have the following advantages like the time delay during charge and discharging is quite short, Capable of controlling the both active and reactive power simultaneously, Loss of power is less, High reliability, High efficiency. Moreover, SMES stabilizes the frequency oscillations by absorbing/injecting the active power.

The closed loop stability of the system with decentralized PI controllers are assessed using the settling time of the system output response. It is observed that the system whose output

response settles fast will have minimum settling time based criterion can be expressed as

$$f(K_p, K_I) = \min(\tau_{si}) \quad (9a)$$

Where τ_{si} is the settling time of the frequency deviation response (ΔF_i) of the i^{th} area under disturbance.

IV. CONTROLLER DESIGN USING ARTIFICIAL BEE COLONY OPTIMIZATION TECHNIQUE FOR THE LOAD-FREQUENCY CONTROL ASSESSMENT PROBLEM

The Artificial Bee Colony [ABC] algorithm which was introduced in 2005 by Karaboga, is used as an optimization search simulates the intelligent foraging behavior of a honey bee swarm. It incorporates a flexible and well-balanced mechanism to adapt to the global and local exploration and exploitation abilities within a short computation time. Due to its simplicity and easy implementation, the ABC algorithm has captured much attention and has been applied to solve many practical optimization problems [10]. This method is efficient in handling large and complex search spaces and it has also been found to be robust in solving problems featuring non-linearity, no differentiability and high dimensionality. Compared with the usual algorithms, the major advantage of ABC algorithm lays in that it conducts both global search and local search in each iteration and as a result the probability of finding the optimal parameters is significantly increased, which efficiently avoid local optimum to a large extent.

In the ABC algorithm, the colony of artificial bees contains three groups of bees: Employed bees, Onlookers and Scouts. A bee waiting on the dance area for making decision to choose a food source is called an Onlooker and a bee going to the food source visited by it previously is named an employed bee. A bee carrying out random search is called a Scout. Communication among bees about the quality of food sources is being achieved in the dancing area by performing waggle dance. In the ABC algorithm, first half of the colony consists of employed artificial bees and the second half constitutes the Onlookers. In other words, the number of employed bees is equal to the number of food sources around the hive. The employed bee whose food source is exhausted by the employed and onlooker bees becomes a scout. The main steps of the algorithm are given below [11]:

1. The search process starts with the random initialization of the bee population.
2. According to the numerical objective functions being examined, the non-dominated solution sets are stored in the archive. The archive is used to store the best estimates of the Pareto front and is updated in each search iteration. The archive updating process contains two steps:
 - a. Firstly, the newly generated solution sets are combined with the non-dominated solution sets already stored in the archives. Then the dominated solutions are removed
 - b. Secondly, if the archive maximal size is reached, a recurrent truncation method based on crowding distance is utilized to remove the least “promising” non-dominated solutions.
3. The diversity-based performance metric, given by $\alpha \in [0,$

1], of the solutions stored in the archive is calculated. α estimates the level of uniformity in the distribution of solutions in the archive set, i.e., if $\alpha=1$ then the solutions are uniformly distributed, whereas with $\alpha=0.6$ we may approximate that 40% of the solutions are not evenly distributed. Note that with $\alpha=0$, the archive set is empty.

4. The current stage of food forage is determined according to the diversity of the archive set. Three stages or phases are distinguished: exploration, transition and exploitation.

5. The bee colony structure (i.e., ratios of elite, follower and scout bees) is adjusted according to α . This adjustment aims at maximizing α (i.e., increase the distribution uniformity of the solutions). The goal is to make the solutions in the archive set evenly distributed. Note that the archive size (K) is equal to the population size.

TABLE 1. BEE COLONY STRUCTURE BASED ON DIVERSITY α

| BEE TYPE | SIZE |
|----------|--|
| ELITE | $(1 - \alpha - s) K$ |
| FOLLOWER | αk |
| SCOUT | $s K;$ ($s = 1/\text{number of variables}$) |

Table I lists the different bee type ratios which were devised according to the following considerations: a). In typical experiments, the generated solution sets exhibit low diversity during the initial phase (i.e., α is low). In such cases the percentage of elite bees performing the waggle dance should be high (i.e., $1-\alpha$ to be high) so that exploration is emphasized. As the search proceeds, the archive set eventually becomes more diversified; the elite bee ratio should then be decreased to facilitate local fine tuning. b). So according to the fitness (i.e., crowding distance) of individual solutions, $(1-\alpha-s) K$ of the bees are selected as elite ones. After that, waggle dance is performed by the elite bees. Note that the number of scout bees is fixed throughout the search.

6. The flying patterns (i.e., the bees' search paths) are also subjected to variation. The scout bees use a polynomial mutation operator (promoting an increase in spread) to explore the search space further. The associated mutation probability is fixed. In contrast, elite and follower bees utilize the Simulated Binary Crossover (SBX) method [12] to exploit the near-optimal generated solutions. The adjustment of flying patterns is achieved through the automated tuning of SBX's distribution index. This is being performed in each iteration. The diversity-based performance metric is again utilized to drive this adjustment.

7. Then, based on the adjusted flying patterns, the bees carry out food foraging.

4.1 ABC algorithm for Load Frequency Control problem

The following algorithm is adopted for the proposed ABC algorithm for LFC problem [10]

1. Initialize the food source position X_i (solutions population) where $i=1, 2 \dots D$
 $[X_i=1, 2, 3 \dots D]$ (10)

2. Calculate the nectar amount of the population by means of their fitness values using:

$$f_i * t_i = 1 / (1 + \text{obj. fun.}_i J) \quad (11)$$

Where obj. fun._i represents equation at solution i

3. Produce neighbor solution V_{ij} for the Employed bees by using equation

$$V_{ij} = X_{ij} + \varphi_{ij} (X_{ij} - X_{kj}) \quad (12)$$

Where $k = (1, 2, 3 \dots D)$ and $j = (1, 2, 3 \dots N)$ are randomly chosen indexes $\Psi \varphi_{ij}$ is a random number between $[-1, 1]$ and evaluate them as indicated in step 2.

4. Apply the greedy selection process for the Employed bees.

5. If all Onlooker bees are distributed, Go to step 9. otherwise, Go to the next step.

6. Calculate the probability values P_i for the solution X_i using by equation

$$P_i = \frac{f_i * t_i}{\sum_{n=1}^N f_i * t_i} \quad (13)$$

7. Produce the neighbor solution V_i for the Onlookers bee from the solution X_i selected depending on P_i and evaluate them.

8. Apply the greedy selection process for the Onlooker bees.

9. In ABC algorithm, providing that a position cannot be improved further through a predetermined number of cycles, then that food source is assumed to be abandoned. The value of pre determined number of cycles is an important control parameter of the ABC algorithm, which is called "limit" for abandonment. Assume that the abandoned source is X_i and $J = (1, 2, 3, N)$, then the Scout discovers a new food source to be replaced with X_i . Determine the abandoned solution for the Scout bees, if it exists, and replace it with a completely new solution X_i^j using the equation

$$X_i^j = X_{min}^j + \text{rand}(0, 1) * (X_{max}^j - X_{min}^j) \quad (14)$$

and evaluate them as indicated in step 2.

10. Memorize the best solution attained so far.

11. If cycle=Maximum Cycle Number (MCN). Stop and print result, otherwise follow step 3.

The Employed and Onlooker bees select new food sources in the neighborhood of the previous one in their memory depending on visual information. Visual information is based on the comparison of food –source positions. On the other hand, Scout bees, without any guidance while looking for a food-source position, explore a completely new food-source position. Therefore Scout bees are characterized based on their behavior by low search costs and a low average in food-source quality. Occasionally, the Scouts bee can be fortunate to discover rich, entirely unknown food sources. In the case of artificial bee, the artificial Scouts bee could have the fast discovery of the group of feasible solutions as the task. Parameter tuning in meta-heuristic optimization algorithms influences the performances of the algorithm significantly. Divergences, becoming trapped in local extreme and time consumption are such consequences of setting the parameter improperly. The ABC algorithm as an advantage has a few controlled parameters, since initializing populations "randomly" with a feasible region is sometimes cumbersome. The ABC algorithm does not depend on the initial population to be in a feasible region.

Instead, its performance directs the population to the feasible region sufficiently [12].

V. CALCULATION OF POWER SYSTEM RESTORATION INDICES

The availability of units in each area with their storage units, with enough margins to pick up the overload ensures whether the load disturbances or disturbance due to the outage of the units have to be given prime importance or not. In this section evaluation index namely Feasible Restoration Indices and Complete Restoration Indices are discussed. These restoration Indices indicate whether the system is in a condition to be restored which can be adjudged with various case studies.

I.PSR Index (I₁), Based on Stability (settling time of ΔF₁)

- 1) Read [A], [B], [Γ] matrices.
From [Y] = [C] [X]
- 2) Solve equation (1) i.e. $\dot{X} = Ax + Bu + \Gamma d$ [14] for a step load disturbance of 1% in area-1 of TATURIPS.
- 3) From the output response of ΔF₁ for 1% step load change in area-1 obtain the settling time ζ_s of ΔF₁.
- 4) PSR Index is obtained as the ratio between the settling time of ΔF₁ and power system time constant. i.e. ε₁, which is referred as Feasible Restoration Index (FRI).

II. PSR Index (I₁), Based on peak overshoot /undershoot of ΔF_i

- 5) Steps 1 and 2 are repeated.
- 6) From the output response of ΔF₁ for step load disturbances of 1% in area-1, the peak undershoot of ΔF₁ is obtained from which PSR Index ε₂ is obtained.

III.PSR Index(I₂),Based on the control input deviation

- 7) Steps 1 and 2 are repeated
- 8) From the control input deviation for 1% step load change in area-1, the PSR Index ε₃ is obtained using Lagrangian's Interpolation method [13],
- 9) PSR Index I₁, I₂ are indices of Feasible Restoration Index when the system is operating in a normal condition with both units in operation where,
I₁ = Min {ε₁, ε₂} and Max {ε₁, ε₂}; I₂ = ε₃.

The FRI computations which are based on the settling time of the output responses related to frequency deviations of both areas in TATURIPS, FRI can be given as

$$\begin{aligned} FRI_{\max} &= \text{Max} \{ FRI_1, FRI_2, FRI_3, FRI_4 \} \\ FRI_{\min} &= \text{Min} \{ FRI_1, FRI_2, FRI_3, FRI_4 \} \end{aligned} \quad (15)$$

IV.Complete Restoration Indices (Based on outage)

- 10) Read [A], [B], [Γ] matrices.
From [Y] = [C] [X]
- 11) Obtain the modified [A], [B], [Γ] matrices by considering outage of one unit in area-1 of a TATURIPS.
- 12) Steps (3) to (8) are repeated for finding PSR Indices I₁, I₂, I₃ by considering outages in one of the units in each area of TATURIPS which are the indices defined as Complete Restoration Index (i.e)

$$CRI = \{ FRI_1, FRI_2, FRI_3, \dots, FRI_7, FRI_8 \} \quad (16)$$

$$\begin{aligned} CRI_{\max} &= \text{Max} \{ FRI_1, FRI_2, FRI_3, \dots, FRI_8 \} \text{ and} \\ CRI_{\min} &= \text{Min} \{ FRI_1, FRI_2, FRI_3, \dots, FRI_8 \} \end{aligned} \quad (17)$$

VI. FOR COMPREHENSIVE ASSESSMENT USING INDICES

The above steps are repeated in carrying out the PSR Indices

- (i) for a step load disturbance of 1% in area-1 for TATURIPS alone and then with SMES unit.
- (ii) for a step load disturbance of 4% in area-1 for TATURIPS alone and then with SMES unit.
- (iii) by considering SMES unit in Area-1 and in Area-2 of TATURIPS repeat (I) to (IV) and then (V)-(i),(ii).

The amount of max peak (or percentage) overshoot/undershoot directly indicate the relative stability of the system. In the transient response specification the max overshoot and the rise time conflict with each other. In other words, both the max overshoot and rise time (which indicates rate of change of control input) cannot be made smaller simultaneously. If one of them is made smaller and the other necessarily becomes larger [14].

VII. SIMULATION RESULTS AND OBSERVATION

The FRI and CRI indicates the possible restoration indices for the TATURIPS with SMES units for different case studies with the output response of the system. The Feasible Restoration Index (FRI) implies a restoration index for different load conditions based on the settling time and Complete Restoration Index (CRI) based on the settling time of the output response of the system with outage of one unit and/or outage of Distribution Generation Capacity to give a secure and reliable operation of TATURIPS under study. Figures 1(a), 1(b) and 2(a), 2(b) represent the respective frequency responses and control input deviations of the case study 1 to 4 i.e. Feasible Restoration responses. Figures 3(a),3(b) and 4(a),4(b) represent the Complete Restoration responses of the case study 5 to 8 as given in appendix 2 and 3 respectively. The results of the ABC tuned gain values, their respective settling time, FRI, CRI and also the peak overshoot value |ε₁| of all the case study has been presented in the table 2 and 3. and control input deviation(ε₂) with respect to the settling has been analyzed and is presented as an index for normal operation with load changes and for outage condition also.

Power System Restoration Assessment:-

- a) based on Settling Time
 - (i) If FRI or CRI is greater than 1 then more amount of distributed generation requirement is needed.
- b) based on peak undershoot of ΔF₁ |ε₁|
 - (i) If FRI or CRI in greater than 0.0194 then the system is vulnerable and the system becomes unstable and may result to blackout.

- (ii) If FRI or CRI is $0.0194 \leq |\epsilon_1| \geq 0.092$ then more amount of distribution generation requirement is needed.
 - (iii) If FRI or CRI is greater than 0.092 not only more amount of distributed generation is required but also load shedding is preferable.
- c) based on control input $\Delta P_c (\epsilon_2)$
- (i) If FRI is ≥ 0.00125 and CRI is ≥ 0.0065 then more amount of distributed generation is needed.
 - (ii) If FRI is ≥ 0.021 and CRI is ≥ 0.031 then more amounts of distributed generation as well as load shedding is preferable.

TABLE 2. RESTORATION INDEX VALUES

| CASE STUDY | SYSTEM | ΔP_d | K_p | K_i | ζ_{s1} | RI based on settling time | RI based on peak under shoot of ΔF |
|------------|---------------|--------------|-------|-------|--------------|---------------------------|--|
| | | | | | | $(\Delta F) \epsilon_1$ | $ \epsilon_2 $ |
| CASE 1 | TATURIPS | 1% | 0.42 | 0.34 | 23 | 1.15 | 0.0195 |
| CASE 2 | TATURIPS+SMES | 1% | 0.39 | 0.25 | 19 | 0.95 | 0.0194 |
| CASE 3 | TATURIPS | 4% | 0.60 | 0.22 | 28 | 1.4 | 0.082 |
| CASE 4 | TATURIPS+SMES | 4% | 0.42 | 0.28 | 20 | 1 | 0.08 |
| CASE 5 | TATURIPS | 1% | 0.42 | 0.34 | 25 | 1.25 | 0.025 |
| CASE 6 | TATURIPS+SMES | 1% | 0.39 | 0.25 | 22 | 1.1 | 0.0237 |
| CASE 7 | TATURIPS | 4% | 0.60 | 0.22 | 30 | 1.5 | 0.092 |
| CASE 8 | TATURIPS+SMES | 4% | 0.42 | 0.28 | 24 | 1.2 | 0.089 |

- CASE 1-4: Both Units in operation (FRI)
- CASE 5-8: With one unit outaged (CRI)

TABLE 3 FRI AND CRI BASED ON MAGNITUDE OF ΔF_1 AND ΔP_c

| SYSTEM | $ \epsilon_2 (\Delta F)$ Based on undershoot | | | | $\epsilon_3 (\Delta P_c)$ Based on control input | | | |
|-----------------|---|-------|--------|-------|---|-------|--------|-------|
| | FRI | | CRI | | FRI | | CRI | |
| | 1% | 4% | 1% | 4% | 1% | 4% | 1% | 4% |
| TATURIPS | 0.0195 | 0.082 | 0.025 | 0.092 | 0.0017 | 0.021 | 0.007 | 0.027 |
| TATURIPS + SMES | 0.0194 | 0.08 | 0.0237 | 0.089 | 0.00125 | 0.018 | 0.0065 | 0.031 |

Power System Restoration Index for Load Frequency Control Assessment Using Artificial Bee Colony Algorithm in a Two-Area Reheat Interconnected Power System Co-ordinated with SMES Units

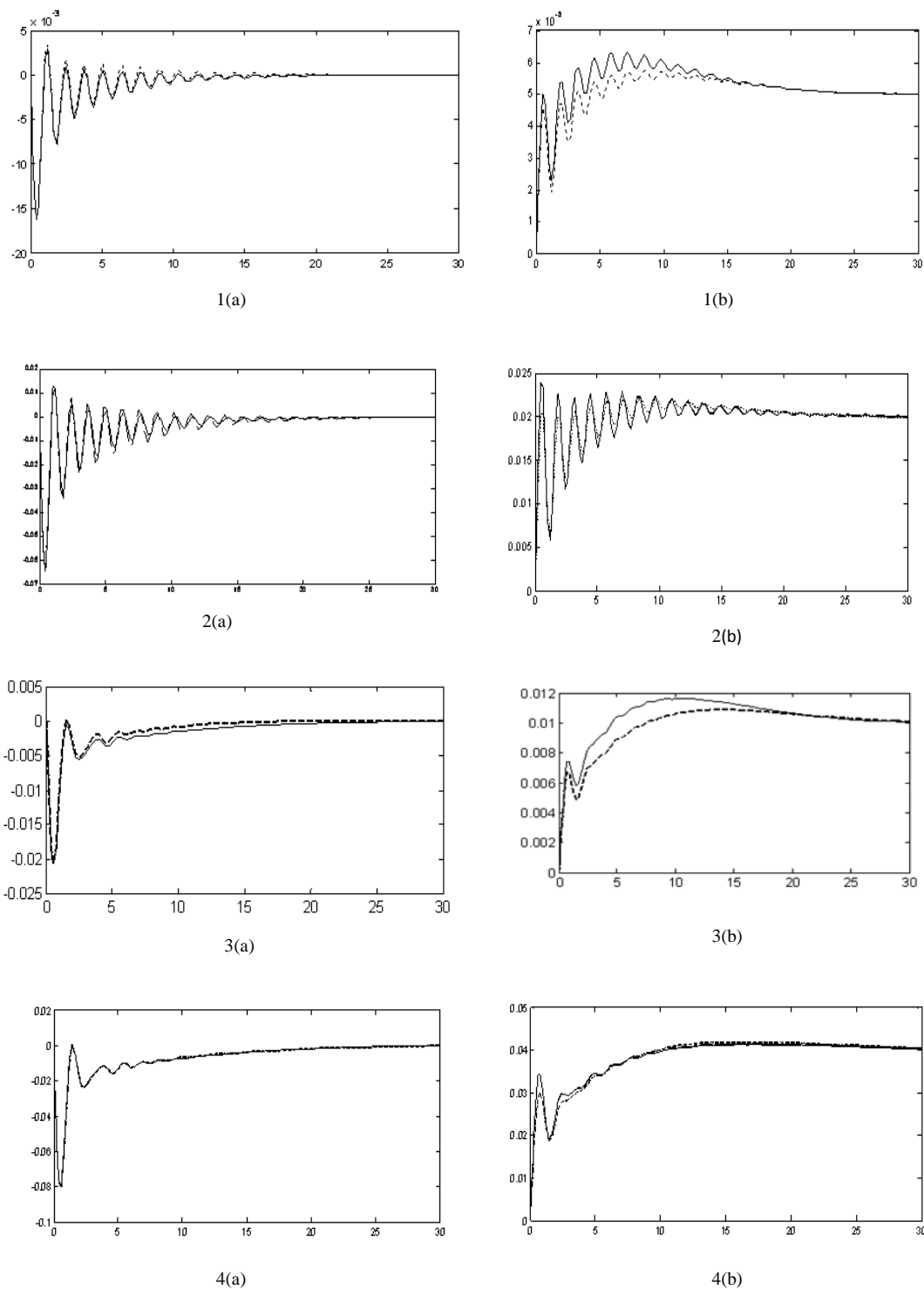

Fig. 5: 1(a), 1(b) and 2(a), 2(b) Frequency deviation and Control input deviation for FRI case study; 3(a),3(b) and 4(a), 4(b) Frequency deviation and Control input deviation for CRI case study X-axis---time in sec,Y-axis(a) --- frequency deviation in HZ,Y-axis(b)---control input deviation in p.u. MW. conventional (dotted line), with SMES unit (solid line).

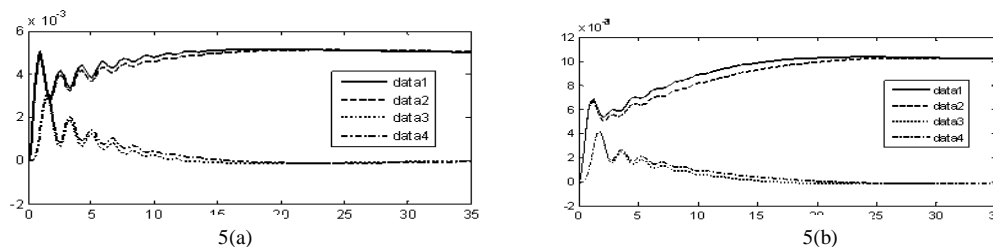

Fig. 6: 5(a), 5(b) --- Mechanical Power Generation output in p.u MW for a step load disturbance of 1% with both units in operation and with one unit in operation respectively. Data1 & Data 4 ---- TATURIPS; Data 2 & Data 3 ---- TATURIPS with SMES unit

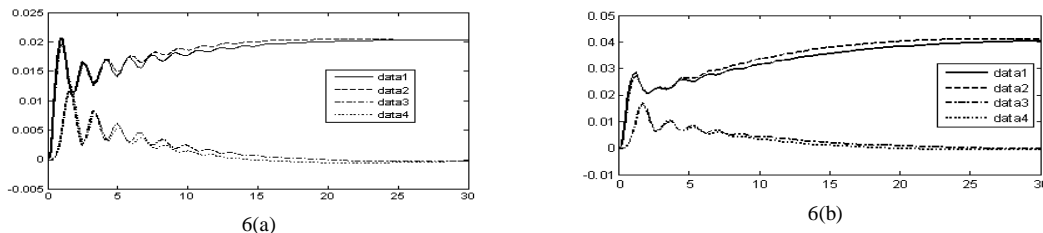

Fig. 7: 6(a), 6(b) --- Mechanical Power Generation output in p.u MW for a step load disturbance of 4% with both units in operation and with one unit in operation respectively. Data1 & Data 3 ---- TATURIPS with SMES unit; Data 2 & Data 4 ---- TATURIPS

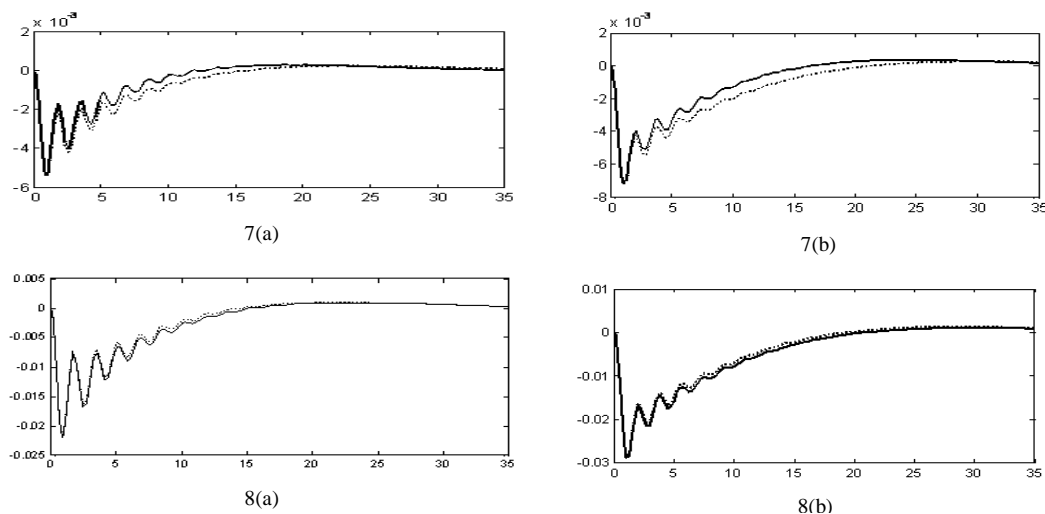

Fig. 8: 7(a),7(b) --- Tie-line Power deviations without and with SMES, both units in operation and Single unit in operation for a step load change of 1% 8(a),8(b) --- Tie-line deviations without and with SMES both units in operation and Single unit in operation for a step load change of 4%, Solid line (TATURIPS), Dotted line (TATURIPS with SMES unit)

VIII. CONCLUSION

The proposed methodology has been implemented on TATURIPS without/with SMES in Area-1 and Area-2 respectively using Artificial Bee Colony algorithm to evaluate how fast the system restores within a short span of time during inter-area oscillations thereby damping out the peak overshoots and frequency deviations due to a considerable limit of load changes. Feasible and Complete Restoration Indices are calculated for various load/outage conditions. It has been found that the TATURIPS with SMES unit ensures better FRI as well as CRI when compared to that of the TATURIPS (conventional) unit alone. Applying the proposed methodology to the system operation, results in enhancing the operating efficiency, securing a full restoration capability, thereby reducing the addition of new power facilities to meet out the load changes.

APPENDIX

A-1 Data for the two-area interconnected thermal power system with reheat turbines (TATURIPS) [5]

$$\begin{aligned}
 P_{r1} &= P_{r2} = 2000 \text{ MW} \\
 K_{p1} &= K_{p2} = 120 \text{ Hz/p.u} \\
 T_{p1} &= T_{p2} = 20 \text{ sec.} \\
 T_{t1} &= T_{t2} = 0.3 \text{ sec.} \\
 T_{g1} &= T_{g2} = 0.08 \text{ sec.} \\
 K_{r1} &= K_{r2} = 0.5 \\
 T_{r1} &= T_{r2} = 10 \text{ sec.} \\
 R_1 &= R_2 = 2.4 \text{ Hz/p.u MW.} \\
 a_{12} &= -1 \\
 T_{12} &= 0.545 \text{ p.u MW/Hz} \\
 \beta_1 &= \beta_2 = 0.425 \text{ p.u. MW/Hz}
 \end{aligned}$$

Power System Restoration Index for Load Frequency Control Assessment Using Artificial Bee Colony Algorithm in a Two-Area Reheat Interconnected Power System Co-ordinated with SMES Units

A-2 Data for the SMES unit [9]

$L=2H$
 $T_{dc}=0.026sec$
 $I_{d0}=4.5KA$
 $K_{id}=0.2 KV/KA$
 $K_{SMES}=50KV/unit MW$
 $I_{dmin}=4.05 KA$
 $I_{dmax}=6.21KA$

A-3 Feasible Restoration Indices

The optimal Proportional plus Integral controller gains are obtained for TATURIPS considering various case studies for framing the Feasible Restoration Indices which were obtained based on the settling time of the output response of the frequency deviations in both areas are as follows:

Case 1: In the TATURIPS with 1% step load disturbance in area-1; the settling time (τ_{s1}) of the frequency deviation in area-1 is obtained and FRI_1 is found as

$$FRI_1 = \tau_{s1} / T_p \quad (A1)$$

Case 2: In the TATURIPS considering SMES in Area-1 and Area-2 respectively with 1% step load disturbance in area1 and the settling time (τ_{s2}) of the frequency deviation in area-1 is obtained and FRI_2 is found as

$$FRI_2 = \tau_{s2} / T_p \quad (A2)$$

Case 3: In the TATURIPS with 4% step load disturbance in area-1; the settling time (τ_{s4}) of the frequency deviation in area-1 is obtained FRI_3 is found as

$$FRI_3 = \tau_{s3} / T_p \quad (A3)$$

Case 4: In the TATURIPS considering SMES in Area-1 and Area-2 respectively with 4% step load disturbance in area1 and the settling time (τ_{s5}) of the frequency deviation in area-1 is obtained and FRI_4 is found as

$$FRI_4 = \tau_{s4} / T_p \quad (A4)$$

Where τ_{s1} , τ_{s2} , τ_{s3} , τ_{s4} are the settling time of the (frequency deviation) output response of the system for various case studies respectively and T_p is the power system time constant. The maximum and minimum Feasible Restoration Indices are obtained as follows:

$$FRI_{max} = \text{Max}\{FRI_1, FRI_2, FRI_3, FRI_4\} \quad (A5)$$

$$FRI_{min} = \text{Min}\{FRI_1, FRI_2, FRI_3, FRI_4\} \quad (A6)$$

A-4 Complete Restoration Indices

Apart from the normal operating condition of the TATURIPS few other case studies like one unit outage in TATURIPS, outage of one distributed generation in TATURIPS are considered. The various case studies obtained based on their optimal gains and their performance index is designated by CRI as follows:

Case5: In the TATURIPS with one unit outaged in area-1 and with 1% stepload disturbance; the settling time is (τ_{s5}) of the frequency deviation in area-1 is obtained and FRI_5 is found as

$$FRI_5 = \tau_{s5} / T_p \quad (A7)$$

Case6: In the TATURIPS considering SMES in Area-1 and Area-2 respectively with 1% stepload disturbance in area1 and the settling time (τ_{s6}) of the frequency deviation in area-1 is obtained and FRI_6 is found as

$$FRI_6 = \tau_{s6} / T_p \quad (A8)$$

Case7: In the TATURIPS with one unit outaged in area-1 and with 4% stepload disturbance; the settling time is (τ_{s7}) of the frequency deviation in area-1 is obtained and FRI_7 is found as

$$FRI_7 = \tau_{s7} / T_p \quad (A9)$$

Case8: In the TATURIPS considering SMES in Area-1 and Area-2 respectively with 4% stepload disturbance in area 1 and the settling time (τ_{s8}) of the frequency deviation in area-1 is obtained and FRI_{11} is found as

$$FRI_8 = \tau_{s8} / T_p \quad (A10)$$

$$CRI = \{FRI_1, FRI_2, FRI_3, \dots, FRI_7, FRI_8\} \quad (A11)$$

$$CRI_{max} = \text{Max}\{FRI_1, FRI_2, FRI_3, \dots, FRI_8\} \quad (A12)$$

and

$$CRI_{min} = \text{Min}\{FRI_1, FRI_2, FRI_3, \dots, FRI_8\} \quad (A13)$$

ACKNOWLEDGEMENT

The authors wish to thank the authorities of Annamalai University, Annamalainagar, Tamilnadu, India for the facilities provided to prepare this paper.

REFERENCES

- [1] H. Shayeghi, H.A. Shayanfar, A. Jalili, "Load Frequency Control Strategies: A state-of-the-art survey for the researcher", Energy Conversion and Management, Vol.50, No.2, pp.344-353, 2009.
- [2] Ibraheem, P. Kumar, D.P. Kothari, "Recent philosophies of automatic generation control strategies in power systems" IEEE Transactions on Power System, Vol.20, No.1, pp. 346-357, 2005.
- [3] Howard F. Illian, "Expanding the requirements for Load Frequency Control" 06GM0675, pp 1-7, IEEE Transactions, 2006.
- [4] R.Roy, P.Bhatt and S.P.Ghoshal, "Evolutionary Computation based Three-Area Automatic Generation Control", Expert Systems with Applications, Vol 37, Issue 8, pp.5913-24, 2010.
- [5] Chidambaram, I.A and S.Velusami, "Design of Decentralized Biased Controllers for Load Frequency Control of Interconnected Power Systems" *Electric Power Components and Systems*, Vol. 33, No.12, pp. 1313-1331, 2005.
- [6] Demiroren A., "Application of a self-tuning to power system with SMES", *European Transactions on Electrical Power (ETEP)*, Vol. 12, No.2, pp.101-109, 2002.
- [7] A.Demiroren, E.Yesil, "Automatic generation control with fuzzy logic controllers in the power system including SMES units", *Electrical Power and Energy Systems*, Vol: 26, pp.291-305, 2004.
- [8] R.J. Abraham, D. Das and A. Patra, "Automatic Generation Control of an Interconnected Hydrothermal Power System Considering Superconducting Magnetic Energy Storage", *Electrical Power and Energy Systems*; 29, pp. 271-579, 2007.
- [9] S.C.Tripathy, R.Balasubramania and P.S.Chandramohan Nair, "Adaptive Automatic Generation Control with Super Conducting Magnetic Energy Storage in Power System", *IEEE Transactions On Energy Conversion*, Vol.7, No.3, pp. 134-141, 1992.
- [10] D.Karaboga and B.Akay, "A Comparative Study of Artificial Bee Colony Algorithm", *Applied Mathematics and Computation*, Vol. 214, pp. 108-132, 2009.
- [11] S.N.Omkar, J.Senthil Nath, R.Khandelwal, G.N.Naik and S.Gopalakrishnan, "Artificial Bee Colony (ABC) for Multi-Objective Design Optimization of Composite Structures", *Applied Soft Computing*, Vol. 11, Issue 1, 2011.
- [12] D.Karaboga, B.Basturk, *Artificial Bee Colony (ABC) Optimization Algorithm for Solving Constrained Optimization Problems*, LNCS: Advances in Soft Computing: Foundations of Fuzzy Logic and Soft Computing, springer-verlag, pp.789-798, and 2007.
- [13] M. Shanthakumar, *Computer Based Numerical Analysis*, Khanna Publishers, New Delhi, 1999.
- [14] Katsuhiko Ogata, *Modern Control Engineering*, Prentice Hall of India, New Delhi, 1986.