

REDUCTION OF τ -TILTING MODULES AND TORSION PAIRS

GUSTAVO JASSO

ABSTRACT. The class of support τ -tilting modules was introduced recently by Adachi, Iyama and Reiten. These modules complete the class of tilting modules from the point of view of mutations. Given a finite dimensional algebra A , we study all basic support τ -tilting A -modules which have given basic τ -rigid A -module as a direct summand. We show that there exist an algebra C such that there exists an order-preserving bijection between these modules and all basic support τ -tilting C -modules; we call this process τ -tilting reduction. An important step in this process is the formation of τ -perpendicular categories which are analogs of ordinary perpendicular categories. Finally, we show that τ -tilting reduction is compatible with silting reduction and 2-Calabi-Yau reduction in appropriate triangulated categories.

CONTENTS

1. Introduction	1
2. Preliminaries	3
2.1. Torsion pairs	4
2.2. τ -tilting theory	4
3. Main results	8
3.1. The τ -perpendicular category	9
3.2. Reduction of torsion classes and τ -tilting modules	12
3.3. Proof of the main theorems	16
4. Compatibility with other types of reduction	21
4.1. Silting reduction	21
4.2. Calabi-Yau reduction	26
References	31

1. INTRODUCTION

Let A be a finite dimensional algebra over a field. Recently, Adachi, Iyama and Reiten introduced in [1] a generalization of classical tilting theory, which they called τ -tilting theory. Motivation to study τ -tilting theory comes from various sources, the most important one is mutation of tilting modules. Mutation of tilting modules has its origin in Bernstein-Gelfand-Ponomarev reflection functors [8], which were later generalized by Auslander, Reiten and Platzeck with the introduction of APR-tilting modules [5], which are obtained by replacing a simple direct summand of the

2010 *Mathematics Subject Classification.* 16G10.

Key words and phrases. τ -tilting theory; torsion pairs; tilting theory; cluster-tilting; silting object; mutation.

The author wishes to thank his Ph.D. supervisor, Prof. O. Iyama, for suggesting these problems and to acknowledge the constant support and valuable comments received from him during the preparation of this article. This acknowledgement is extended to D. Yang for helpful discussions on the subject and to R. Kase for pointing out the connection with known results for hereditary algebras.

tilting A -module A . Mutation of tilting modules was introduced in full generality by Riedtmann and Schofield in their combinatorial study of tilting modules [26]. Also, Happel and Unger showed in [16] that tilting mutation is intimately related to the partial order of tilting modules induced by the inclusion of the associated torsion classes.

We note that one limitation of mutation of tilting modules is that it is not always possible. This is the motivation for the introduction of τ -tilting theory. Support τ -tilting (resp. τ -rigid) A -modules are a generalization of tilting (resp. partial-tilting) A -modules defined in terms of the Auslander-Reiten translation, see Definition 2.7. Support τ -tilting modules can be regarded as a “completion” of the class of tilting modules from the point of view of mutation. In fact, it is shown in [1, Thm. 2.17] that a basic almost-complete support τ -tilting A -module is the direct summand of exactly two basic support τ -tilting A -modules. This means that mutation of support τ -tilting A -modules is always possible.

It is then natural to consider more generally all support τ -tilting A -modules which have a given τ -rigid A -module U as a direct summand. Our main result is the following bijection:

Theorem 1.1 (see Theorem 3.15 for details). *Let U be a basic τ -rigid A -module. Then there exists a finite dimensional algebra C such that there is an order-preserving bijection between the set of isomorphism classes of basic support τ -tilting A -modules which have U as a direct summand and the set of isomorphism classes of all basic support τ -tilting C -modules. We call this process τ -tilting reduction.*

As a special case of Theorem 1.1 we obtain an independent proof of [1, Thm. 2.17].

Corollary 1.2 (Corollary 3.17). *Every almost-complete support τ -tilting A -module is the direct summand of exactly two support τ -tilting A -modules.*

If we restrict ourselves to hereditary algebras, then Theorem 1.1 gives the following improvement of [17, Thm. 3.4], where U is assumed to be faithful.

Corollary 1.3 (Corollary 3.18). *Let A be a hereditary algebra and U be a basic partial-tilting A -module. Then there exists a hereditary algebra C such that there is an order-preserving bijection between the set of isomorphism classes of basic support tilting A -modules which have U as a direct summand and the set of isomorphism classes of all basic support tilting C -modules.*

Now we explain a category equivalence which plays a fundamental role in the proof of Theorem 1.1, and which is of independent interest. Given a τ -rigid module U , there are two torsion pairs in $\text{mod } A$ which are naturally associated to U . Namely, $(\text{Fac } U, U^\perp)$ and $({}^\perp(\tau U), \text{Sub}(\tau U))$. We have the following result about the category ${}^\perp(\tau U) \cap U^\perp$, which is an analog of the perpendicular category associated with U in the sense of [14], see Example 3.4.

Theorem 1.4 (Theorem 3.8). *With the hypotheses of Theorem 1.1, let T_U be the Bongartz completion of U in $\text{mod } A$. Then, the functor $\text{Hom}_A(T_U, -) : \text{mod } A \rightarrow \text{mod}(\text{End}_A(T_U))$ induces an equivalence of exact categories*

$$F : {}^\perp(\tau U) \cap U^\perp \longrightarrow \text{mod } C.$$

It is shown in [1, Thm. 2.2] that basic support τ -tilting A -modules are precisely the Ext-progenerators of functorially finite torsion classes in $\text{mod } A$. The proof of Theorem 1.1 makes heavy use of the bijection between functorially finite torsion classes in $\text{mod } A$ and basic support τ -tilting A -modules. The following result extends the bijection given in Theorem 1.1, as the torsion classes involved do not need to be functorially finite:

Theorem 1.5 (Theorem 3.12). *With the hypotheses of Theorem 1.1, the map*

$$\mathcal{T} \mapsto F(\mathcal{T} \cap U^\perp)$$

induces a bijection between torsion classes \mathcal{T} in $\text{mod } A$ such that $\text{Fac } U \subseteq \mathcal{T} \subseteq {}^\perp(\tau U)$ and torsion classes in $\text{mod } C$, where F is the equivalence obtained in Theorem 1.4.

We would like to point out that support τ -tilting modules are related with important classes of objects in representation theory: silting objects in triangulated categories and cluster-tilting objects in 2-Calabi-Yau triangulated categories. On one hand, if \mathcal{T} is a triangulated category satisfying suitable finiteness conditions with a silting object S , then there is a bijection between basic silting objects contained in the subcategory $S*S[1]$ of \mathcal{T} and basic support τ -tilting $\text{End}_{\mathcal{T}}(S)$ -modules, see [1, Thm. 3.2] for a special case. On the other hand, if \mathcal{C} is a 2-Calabi-Yau triangulated category with a cluster-tilting object T , then there is a bijection between basic cluster-tilting objects in \mathcal{C} and basic support τ -tilting $\text{End}_{\mathcal{C}}(T)$ -modules, see [1, Thm. 4.1].

Reduction techniques exist both for silting objects and cluster-tilting objects, see [3, Thm. 2.37] and [22, Thm. 4.9] respectively. The following result shows that τ -tilting reduction fits nicely in these contexts.

Theorem 1.6 (see Theorems 4.12 and 4.23 for details). *Let A be a finite dimensional algebra. Then we have the following:*

- (a) *τ -tilting reduction is compatible with silting reduction.*
- (b) *If A is 2-Calabi-Yau tilted, then τ -tilting reduction is compatible with 2-Calabi-Yau reduction.*

These results enhance our understanding of the relationship between silting objects, cluster-tilting objects and support τ -tilting modules. We refer the reader to [9] for an in-depth survey of the relations between these objects and several other important concepts in representation theory.

Finally, let us fix our conventions and notations, which we kindly ask the reader to keep in mind for the remainder of this article.

Conventions 1.7. In what follows, A always denotes a (fixed) finite dimensional algebra over a field k . We denote by $\text{mod } A$ the category of finite dimensional right A -modules. Whenever we consider a subcategory of $\text{mod } A$ we assume that it is full and closed under isomorphisms. If M is an A -module, we denote by $\text{Fac } M$ the subcategory of $\text{mod } A$ which consists of all factor modules of direct sums of copies of M ; the subcategory $\text{Sub } M$ is defined dually. Given morphisms $f : X \rightarrow Y$ and $g : Y \rightarrow Z$ in some category \mathcal{C} , we denote their composition by $g \circ f = gf$. Given a subcategory \mathcal{X} of an additive category \mathcal{C} , we denote by ${}^\perp\mathcal{X}$ the subcategory of \mathcal{C} whose objects are all objects M in \mathcal{C} such that $\text{Hom}_{\mathcal{C}}(M, \mathcal{X}) = 0$; the category \mathcal{X}^\perp is defined dually. Also, we denote by $[\mathcal{X}]$ the ideal of \mathcal{C} of morphisms which factor through \mathcal{X} . For an object X of \mathcal{C} , we denote by $\text{add } X$ the smallest additive subcategory of \mathcal{C} containing X and closed under isomorphisms. If $\mathcal{X} = \text{add } X$ for some object X in \mathcal{C} we write ${}^\perp X$ instead of ${}^\perp\mathcal{X}$ and so on. If \mathcal{C} is a k -linear category we denote by D the usual k -duality $\text{Hom}_k(-, k)$.

2. PRELIMINARIES

There is a strong interplay between the classical concept of torsion class in $\text{mod } A$ and the recently investigated class of support τ -tilting modules. In this section we collect the basic definitions and main results relating this two theories.

2.1. Torsion pairs. Recall that a subcategory \mathcal{X} of an additive category \mathcal{C} is said to be *contravariantly finite in \mathcal{C}* if for every object M of \mathcal{C} there exist some X in \mathcal{X} and a morphism $f : X \rightarrow M$ such that for every X' in \mathcal{X} the sequence

$$\mathrm{Hom}_{\mathcal{C}}(X', X) \xrightarrow{f} \mathrm{Hom}_{\mathcal{C}}(X', M) \rightarrow 0$$

is exact. In this case f is called a *right \mathcal{X} -approximation*. Dually we define *covariantly finite subcategories in \mathcal{C}* and *left \mathcal{X} -approximations*. Furthermore, a subcategory of \mathcal{C} is said to be *functorially finite in \mathcal{C}* if it is both contravariantly and covariantly finite in \mathcal{C} .

A subcategory \mathcal{T} of $\mathrm{mod} A$ is called a *torsion class* if it is closed under extensions and factor modules in $\mathrm{mod} A$. Dually, *torsion-free classes* are defined. An A -module M in \mathcal{T} is said to be *Ext-projective in \mathcal{T}* if $\mathrm{Ext}_A^1(M, \mathcal{T}) = 0$. If \mathcal{T} is functorially finite in $\mathrm{mod} A$, then there are only finitely many indecomposable Ext-projective modules in \mathcal{T} up to isomorphism, and we denote by $P(\mathcal{T})$ the direct sum of each one of them. For convenience, we will denote the set of all torsion classes in $\mathrm{mod} A$ by $\mathrm{tors} A$, and by $\mathrm{f-tors} A$ the subset of $\mathrm{tors} A$ consisting of all torsion classes which are functorially finite in $\mathrm{mod} A$.

A pair $(\mathcal{T}, \mathcal{F})$ of subcategories of $\mathrm{mod} A$ is called a *torsion pair* if $\mathcal{F} = \mathcal{T}^\perp$ and $\mathcal{T} = {}^\perp \mathcal{F}$. In such case \mathcal{T} is a torsion class and \mathcal{F} is a torsion-free class in $\mathrm{mod} A$. The following proposition characterizes torsion pairs in $\mathrm{mod} A$ consisting of functorially finite subcategories.

Proposition 2.1. [1, Prop. 1.1] *Let $(\mathcal{T}, \mathcal{F})$ be a torsion pair in $\mathrm{mod} A$. The following properties are equivalent:*

- (a) \mathcal{F} is functorially finite in $\mathrm{mod} A$ (or equivalently, \mathcal{F} is contravariantly finite).
- (b) \mathcal{T} is functorially finite in $\mathrm{mod} A$ (or equivalently, \mathcal{T} is covariantly finite).
- (c) $\mathcal{T} = \mathrm{Fac} P(\mathcal{T})$.
- (d) $P(\mathcal{T})$ is a tilting $(A/\mathrm{ann} \mathcal{T})$ -module.
- (e) For every M in \mathcal{T} there exists a short exact sequence $0 \rightarrow L \rightarrow T' \xrightarrow{f} M \rightarrow 0$ where f is right $(\mathrm{add} P(\mathcal{T}))$ -approximation and L is in \mathcal{T} .

A torsion pair in $\mathrm{mod} A$ which has any of the equivalent properties of Proposition 2.1 is called a *functorially finite torsion pair*. In view of property (c), we call the A -module $P(\mathcal{T})$ the *Ext-progenerator* of \mathcal{T} .

2.2. τ -tilting theory. Now we recall the definition of support τ -tilting modules and the results relating such modules with functorially finite torsion classes in $\mathrm{mod} A$.

Definition 2.2. [1, Def. 0.1(a)] Let A be a finite dimensional algebra. An A -module M is said to be *τ -rigid* if $\mathrm{Hom}_A(M, \tau M) = 0$ where τ is the Auslander-Reiten translation.

Remark 2.3. By the Auslander-Reiten duality formula [4, Thm. IV.2.13], for every A -module M we have an isomorphism $D\overline{\mathrm{Hom}}_A(M, \tau M) \cong \mathrm{Ext}_A^1(M, M)$. Thus M is rigid (i.e. $\mathrm{Ext}_A^1(M, M) = 0$) provided M is τ -rigid.

The following classical result of Auslander and Smalø characterizes τ -rigid modules in terms of torsion classes.

Proposition 2.4. [7, 5.8] *Let M and N be two A -modules. Then the following holds:*

- (a) $\mathrm{Hom}_A(N, \tau M) = 0$ if and only if $\mathrm{Ext}_A^1(M, \mathrm{Fac} N) = 0$.
- (b) M is τ -rigid if and only if M is Ext-projective in $\mathrm{Fac} M$.

(c) $\text{Fac } M$ is a functorially finite torsion class in $\text{mod } A$.

For an A -module M and an ideal I of A contained in $\text{ann } M$, the following proposition describes the relationship between M being τ -rigid as A -module and τ -rigid as (A/I) -module. We denote by $\tau_{A/I}$ the Auslander-Reiten translation in $\text{mod } (A/I)$.

Proposition 2.5. [1, Lemma 2.1] *Let I be an ideal of A and M and N two (A/I) -modules. Then we have the following:*

- (a) *If $\text{Hom}_A(M, \tau N) = 0$, then $\text{Hom}_{A/I}(M, \tau_{A/I}N) = 0$.*
- (b) *If $I = \langle e \rangle$ for some idempotent $e \in A$, then $\text{Hom}_A(M, \tau N) = 0$ if and only if $\text{Hom}_{A/I}(M, \tau_{A/I}N) = 0$.*

The following lemma, which is an analog of Wakamatsu's Lemma, cf. [6, Lemma 1.3], often comes handy.

Lemma 2.6. [1, Lemma 2.5] *Let $0 \rightarrow L \rightarrow M \xrightarrow{f} N$ be an exact sequence. If f is a right (add M)-approximation of N and M is τ -rigid, then L is in ${}^\perp(\tau M)$.*

We denote the number of pairwise non-isomorphic indecomposable summands of an A -module M by $|M|$. Thus $|A|$ equals the rank of the Grothendieck group of $\text{mod } A$.

Definition 2.7. [1, Defs. 0.1(b), 0.3] *Let M be a τ -rigid A -module. We say that M is a τ -tilting A -module if $|M| = |A|$. More generally, we say that M is a support τ -tilting A -module if there exists an idempotent $e \in A$ such that M is a τ -tilting $(A/\langle e \rangle)$ -module. Support tilting A -modules are defined analogously, see [18].*

Remark 2.8. Note that the zero-module is a support τ -tilting module (take $e = 1_A$ in Definition 2.7). Thus every non-zero finite dimensional algebra A admits at least two support τ -tilting A -modules: 0 and A .

The following observation follows immediately from the Auslander-Reiten formulas and Definition 2.7.

Proposition 2.9. [1] *Let A be a hereditary algebra and M an A -module. Then M is a τ -rigid (resp. τ -tilting) A -module if and only if M is a rigid (resp. tilting) A -module.*

We also need the following result:

Proposition 2.10. [1, Prop. 2.2] *Let A be a finite dimensional algebra. The following statements hold:*

- (a) *τ -tilting A -modules are precisely sincere support τ -tilting A -modules.*
- (b) *Tilting A -modules are precisely faithful support τ -tilting A -modules.*
- (c) *Any τ -tilting (resp. τ -rigid) A -module M is a tilting (resp. partial tilting) $(A/\text{ann } T)$ -module.*

The following result provides the conceptual framework for the main results of this article. It says that basic support τ -tilting A -modules are precisely the Ext-progenerators of functorially finite torsion classes in $\text{mod } A$.

Theorem 2.11. [1, Thm. 2.2] *There is a bijection*

$$\text{f-tors } A \longrightarrow \text{s}\tau\text{-tilt } A$$

given by $\mathcal{T} \mapsto P(\mathcal{T})$ with inverse $M \mapsto \text{Fac } M$.

Remark 2.12. Observe that the inclusion of subcategories gives a partial order in $\text{tors } A$. Thus the bijection of Theorem 2.11 induces a partial order in $s\tau\text{-tilt } A$. Namely, if M and N are support τ -tilting A -modules, then

$$M \leq N \quad \text{if and only if} \quad \text{Fac } M \subseteq \text{Fac } N.$$

Hence, as with every partially ordered set, we can associate to $s\tau\text{-tilt } A$ a *Hasse quiver* $Q(s\tau\text{-tilt } A)$ whose set of vertices is $s\tau\text{-tilt } A$ and there is an arrow $M \rightarrow N$ if and only if $M > N$ and there is no $L \in s\tau\text{-tilt } A$ such that $M > L > N$.

The following proposition is a generalization of Bongartz completion of tilting modules, see [4, Lemma VI.2.4]. It plays an important role in the sequel.

Proposition 2.13. [1, Prop. 2.9] *Let U be a τ -rigid A -module. Then the following holds:*

- (a) ${}^\perp(\tau U)$ is a functorially finite torsion class which contains U .
- (b) U is Ext-projective in ${}^\perp(\tau U)$, that is $U \in \text{add } P({}^\perp(\tau U))$.
- (c) $T_U := P({}^\perp(\tau U))$ is a τ -tilting A -module.

The module T_U is called the Bongartz completion of U in $\text{mod } A$.

Recall that, by definition, a partial-tilting A -module T is a tilting A -module if and only if there exists a short exact sequence $0 \rightarrow A \rightarrow T' \rightarrow T'' \rightarrow 0$ with $T', T'' \in \text{add } T$. The following proposition gives a similar criterion for a τ -rigid A -module to be a support τ -tilting A -module.

Proposition 2.14. *Let M be a τ -rigid A -module. Then M is a support τ -tilting A -module if and only if there exists an exact sequence*

$$(1) \quad A \xrightarrow{f} M' \xrightarrow{g} M'' \rightarrow 0$$

with $M', M'' \in \text{add } M$ and f a left $(\text{add } M)$ -approximation of A .

Proof. The necessity is shown in [1, Prop. 2.22]. For the sufficiency, suppose there exists an exact sequence of the form (1). Let $I = \text{ann } M$, we only need to find an idempotent $e \in A$ such that $e \in I$ and $|M| = |A/\langle e \rangle|$. By Proposition 2.10(c) M is a partial-tilting (A/I) -module. Moreover, f induces a morphism $\bar{f} : A/I \rightarrow M'$. We claim that the sequence

$$0 \rightarrow A/I \xrightarrow{\bar{f}} M' \xrightarrow{g} M'' \rightarrow 0$$

is exact, for which we only need to show that the induced morphism \bar{f} is injective. It is easy to see that $\bar{f} : A/I \rightarrow M'$ is a left $(\text{add } M)$ -approximation of A/I . Since M is a faithful (A/I) -module, by [4, VI.2.2] we have that \bar{f} is injective, and the claim follows. Thus M is a tilting (A/I) -module, and we have $|M| = |A/I|$. Let e be a maximal idempotent in A such that $e \in I$. Then by the choice of e we have that $|M| = |A/I| = |A/\langle e \rangle|$. \square

The following result justifies the claim that support τ -tilting modules complete the class of tilting modules from the point of view of mutation. We say that a basic τ -rigid A -module U is *almost-complete* if $|U| = |A| - 1$.

Theorem 2.15. [1, Thm. 2.17] *Let U be an almost-complete τ -tilting A -module. Then there exist exactly two basic support τ -tilting A -modules having U as a direct summand.*

Definition 2.16. It follows from Theorem 2.15 that we can associate with $s\tau\text{-tilt } A$ an *exchange graph* whose vertices are basic support τ -tilting A -modules and there is an edge between two non-isomorphic support τ -tilting A -modules M and N if and only if the following holds:

- There exists an idempotent $e \in A$ such that $M, N \in \text{mod}(A/\langle e \rangle)$.
- There exists an almost-complete τ -tilting $(A/\langle e \rangle)$ -module U such that $U \in \text{add } M$ and $U \in \text{add } N$.

In this case we say that M and N are obtained from each other by mutation. Note that this exchange graph is n -regular, where $|A| = n$ is the number of simple A -modules. It is shown in [1, Cor. 2.31] that the underlying graph of $Q(\text{s}\tau\text{-tilt } A)$ coincides with the exchange graph of $\text{s}\tau\text{-tilt } A$.

We conclude this section with some examples of support τ -tilting modules.

Example 2.17. Let A be a hereditary algebra. By Proposition 2.10 support τ -tilting A -modules are precisely support tilting A -modules. For example, let A be the path algebra of the quiver $2 \leftarrow 1$. The Auslander-Reiten quiver of $\text{mod } A$ is given by

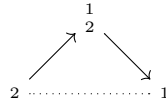

where modules are represented by their radical filtration. Then $Q(\text{s}\tau\text{-tilt } A)$ is given by

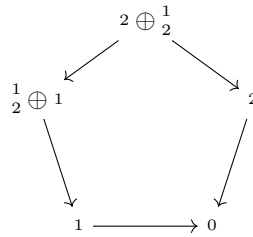

Note that the only τ -tilting A -modules are $2 \oplus \frac{1}{2}$ and $\frac{1}{2} \oplus 1$, and since A is hereditary they are also tilting A -modules.

Example 2.18. Let A be the algebra given by the quiver

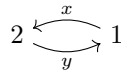

subject to the relation $yx = 0$. The Auslander-Reiten quiver of $\text{mod } A$ is given by

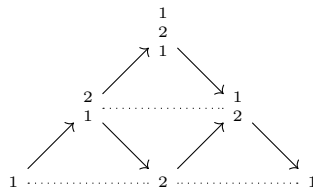

where the two copies of $S_1 = 1$ are to be identified. Then $Q(\text{s}\tau\text{-tilt } A)$ is given as follows:

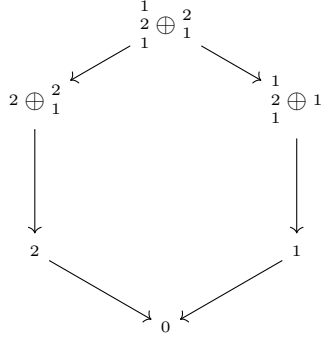

Example 2.19. Let A be a self-injective algebra. Then the only basic tilting A -module is A . On the other hand, in general there are many basic support τ -tilting modules. For example, let A be the path algebra of the quiver

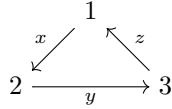

subject to the relations $xy = 0$, $yz = 0$ and $zx = 0$. Thus A is a self-injective cluster-tilted algebra of type A_3 , see [11, 27]. It follows from [1, Thm. 4.1] that basic support τ -tilting A -modules correspond bijectively with basic cluster-tilting objects in the cluster category of type A_3 . Hence there are 14 support τ -tilting A -modules, see [10, Fig. 4].

The following example gives an algebra with infinitely many support τ -tilting modules.

Example 2.20. Let A be the Kronecker algebra, *i.e.* the path algebra of the quiver $2 \rightleftarrows 1$. Then $Q(\text{s}\tau\text{-tilt } A)$ is the following quiver, where each module is represented by its radical filtration:

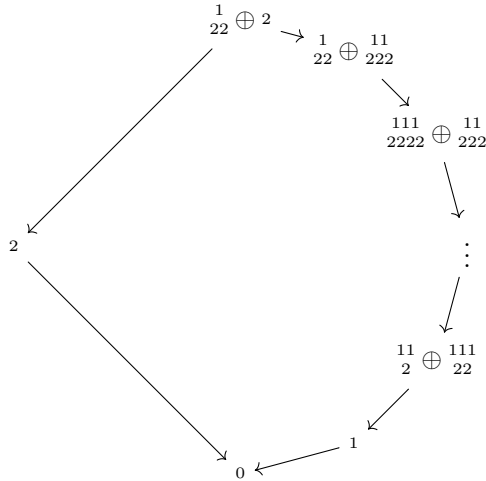

3. MAIN RESULTS

This section is devoted to prove the main results of this article. First, let us fix the setting of our results.

Setting 3.1. We fix a finite dimensional algebra A and a basic τ -rigid A -module U . Let $T = T_U$ be the Bongartz completion of U in $\text{mod } A$, see Proposition 2.13.

The algebras

$$B = B_U := \text{End}_A(T_U) \quad \text{and} \quad C = C_U := B_U / \langle e_U \rangle$$

play an important role in the sequel, where e_U is the idempotent corresponding to the projective B -module $\text{Hom}_A(T_U, U)$. We regard $\text{mod } C$ as a full subcategory of $\text{mod } B$ via the canonical embedding.

In this section we study the subset of $s\tau$ -tilt A given by

$$s\tau\text{-tilt}_U A := \{M \in s\tau\text{-tilt } A \mid U \in \text{add } M\}.$$

In Theorem 3.15 we will show that there is an order-preserving bijection between $s\tau\text{-tilt}_U A$ and $s\tau\text{-tilt } C$.

3.1. The τ -perpendicular category. The following observation allows us to describe $s\tau\text{-tilt } A$ in terms of the partial order in $\text{tors } A$.

Proposition 3.2. [1, Prop. 2.8] *Let U be a τ -rigid A -module and M a support τ -tilting A -module. Then, $U \in \text{add } M$ if and only if*

$$\text{Fac } U \subseteq \text{Fac } M \subseteq {}^\perp(\tau U).$$

Recall that we have $M \leq N$ for two basic support τ -tilting A -modules if and only if $\text{Fac } M \subseteq \text{Fac } N$, see Remark 2.12. Hence it follows from Proposition 3.2 that $s\tau\text{-tilt}_U A$ is an interval in $s\tau\text{-tilt } A$, i.e. we have that

$$(2) \quad s\tau\text{-tilt}_U A = \{M \in s\tau\text{-tilt } A \mid P(\text{Fac } U) \leq M \leq T_U\}$$

In particular there are two distinguished functorially finite torsion pairs associated with $P(\text{Fac } U)$ and T_U . Namely,

$$(\text{Fac } U, U^\perp) \quad \text{and} \quad ({}^\perp(\tau U), \text{Sub } \tau U)$$

which satisfy $\text{Fac } U \subseteq {}^\perp(\tau U)$ and $\text{Sub } \tau U \subseteq U^\perp$.

Definition 3.3. The τ -perpendicular category associated to U is the subcategory of $\text{mod } A$ given by $\mathcal{U} := {}^\perp(\tau U) \cap U^\perp$.

The choice of terminology in Definition 3.3 is justified by the following example.

Example 3.4. Suppose that U is a partial-tilting A -module. Since U has projective dimension less or equal than 1. Then, by the Auslander-Reiten formulas, for every A -module M we have that $\text{Hom}_A(M, \tau U) = 0$ if and only if $\text{Ext}_A^1(U, M) = 0$. Then

$$\mathcal{U} = \{M \in \text{mod } A \mid \text{Hom}(U, M) = 0 \text{ and } \text{Ext}_A^1(U, M) = 0\}.$$

Thus \mathcal{U} is exactly the right perpendicular category associated to U in the sense of [14].

We need a simple observation which is a consequence of a theorem of Brenner and Butler.

Proposition 3.5. *With the hypotheses of Setting 3.1, the functors*

$$(3) \quad F := \text{Hom}_A(T, -) : \text{mod } A \rightarrow \text{mod } B \quad \text{and}$$

$$(4) \quad G := - \otimes_B T : \text{mod } B \rightarrow \text{mod } A$$

induce mutually quasi-inverse equivalences $F : \text{Fac } T \rightarrow \text{Sub } DT$ and $G : \text{Sub } DT \rightarrow \text{Fac } T$. Moreover, these equivalences are exact, i.e. F sends short exact sequences in $\text{mod } A$ with terms in $\text{Fac } T$ to short exact sequences in $\text{mod } B$, and so does G .

Proof. In view of Proposition 2.10, we have that T is a tilting $(A/\text{ann}T)$ -module. Then it follows from [4, Thm. VI.3.8] that $F : \text{Fac}T \rightarrow \text{Sub}DT$ is an equivalence with quasi-inverse $G : \text{Sub}DT \rightarrow \text{Fac}T$.

Now we show that both F and G are exact. For this, let $0 \rightarrow L \rightarrow M \rightarrow N \rightarrow 0$ be a short exact sequence in $\text{mod}A$ with terms in $\text{Fac}T$. Then F induces an exact sequence

$$0 \rightarrow FL \rightarrow FM \rightarrow FN \rightarrow \text{Ext}_A^1(T, L) = 0$$

as T is Ext-projective in ${}^\perp(\tau U)$. Consequently F is exact.

Next, let $0 \rightarrow L' \rightarrow M' \rightarrow N' \rightarrow 0$ be a short exact sequence in $\text{mod}A$ with terms in $\text{Sub}DT$, then there is an exact sequence

$$0 = \text{Tor}_1^B(N', T) \rightarrow GL' \rightarrow GM' \rightarrow GN' \rightarrow 0.$$

as $N' \in \text{Sub}DT = \ker \text{Tor}_1^B(-, T)$, see [4, Cor. VI.3.9(i)]; hence G is also exact. \square

The following proposition gives us a basic property of \mathcal{U} .

Proposition 3.6. *Let $0 \rightarrow L \rightarrow M \rightarrow N \rightarrow 0$ be an exact sequence in $\text{mod}A$. If any two of L , M and N belong to \mathcal{U} , then the third one also belongs to \mathcal{U} .*

Proof. First, \mathcal{U} is closed under extensions since both ${}^\perp(\tau U)$ and U^\perp are closed under extensions in $\text{mod}A$. Thus if L and N belong to \mathcal{U} , then so does M .

Secondly, suppose that L and M belong to \mathcal{U} . Since ${}^\perp(\tau U)$ is closed under factor modules we only need to show that $\text{Hom}_A(U, N) = 0$. In this case we have an exact sequence

$$0 = \text{Hom}_A(U, M) \rightarrow \text{Hom}_A(U, N) \rightarrow \text{Ext}_A^1(U, L) = 0$$

since by Proposition 2.13(b) we have that U is Ext-projective in ${}^\perp(\tau U)$, hence N is in \mathcal{U} .

Finally, suppose that M and N belong to \mathcal{U} . Since U^\perp is closed under submodules, we only need to show that $\text{Hom}_A(L, \tau U) = 0$. We have an exact sequence

$$0 = \text{Hom}_A(M, \tau U) \rightarrow \text{Hom}_A(L, \tau U) \rightarrow \text{Ext}_A^1(N, \tau U).$$

By the dual of Proposition 2.13(b) we have that τU is Ext-injective in U^\perp , so we have $\text{Ext}_A^1(N, \tau U) = 0$, hence $\text{Hom}_A(L, \tau U) = 0$ and thus L is in \mathcal{U} . \square

Remark 3.7. Since \mathcal{U} is closed under extensions in $\text{mod}A$, it has a natural structure of an exact category, see [25, 23]. Then Proposition 3.6 says that admissible epimorphisms (resp. admissible monomorphisms) in \mathcal{U} are exactly epimorphisms (resp. monomorphisms) in $\text{mod}A$ between modules in \mathcal{U} .

The next result is the main result of this subsection. It is the first step towards τ -tilting reduction.

Theorem 3.8. *With the hypotheses of Setting 3.1, the functors F and G in Proposition 3.5 induce mutually quasi-inverse equivalences $F : \mathcal{U} \rightarrow \text{mod}C$ and $G : \text{mod}C \rightarrow \mathcal{U}$ which are exact.*

Proof. By Proposition 3.5, the functors (3) and (4) induce mutually quasi-inverse equivalences between $\text{Fac}T$ and $\text{Sub}DT$. Hence by construction we have $F(\mathcal{U}) \subseteq (FU)^\perp = \text{mod}C$. Thus, we only need to show that $F : \mathcal{U} \rightarrow \text{mod}C$ is dense.

Let N be in $\text{mod}C$ and take a projective presentation

$$(5) \quad FT_1 \xrightarrow{Ff} FT_0 \rightarrow N \rightarrow 0$$

of the B -module N ; hence we have $T_0, T_1 \in T_U$. Let $M = \text{Coker} f$. We claim that $FM \cong N$ and that M is in \mathcal{U} . In fact, let $L = \text{Im} f$ and $K = \text{Ker} f$. Then we have

short exact sequences

$$(6) \quad 0 \rightarrow K \rightarrow T_1 \rightarrow L \rightarrow 0 \quad \text{and}$$

$$(7) \quad 0 \rightarrow L \rightarrow T_0 \rightarrow M \rightarrow 0.$$

Then L is in ${}^\perp(\tau U)$ since ${}^\perp(\tau U)$ is closed under factor modules. In particular we have that $\text{Ext}_A^1(T, L) = 0$. Apply the functor F to the short exact sequences (6) and (7) to obtain a commutative diagram with exact rows and columns

$$\begin{array}{ccccccc} & & FT_1 & \xrightarrow{Ff} & FT_0 & \longrightarrow & FM \\ & & \downarrow & & \parallel & & \parallel \\ 0 & \longrightarrow & FL & \longrightarrow & FT_0 & \longrightarrow & FM \longrightarrow \text{Ext}_A^1(T, L) = 0 \\ & & \downarrow & & & & \\ & & \text{Ext}_A^1(T, K) & & & & \end{array}$$

To prove that $FM \cong N$ it remains to show that $\text{Ext}_A^1(T, K) = 0$. Since T is Ext-projective in ${}^\perp(\tau U)$, it suffices to show that K is in ${}^\perp(\tau U)$. Applying the functor $\text{Hom}_A(-, \tau U)$ to (6), we obtain an exact sequence

$$0 = \text{Hom}_A(T_1, \tau U) \rightarrow \text{Hom}_A(K, \tau U) \rightarrow \text{Ext}_A^1(L, \tau U) \xrightarrow{\text{Ext}_A^1(f, \tau U)} \text{Ext}_A^1(T_1, \tau U).$$

Thus we only need to show that the map $\text{Ext}_A^1(f, \tau U) : \text{Ext}_A^1(L, \tau U) \rightarrow \text{Ext}_A^1(T_1, \tau U)$ is a monomorphism. By Auslander-Reiten duality it suffices to show that the map

$$\underline{\text{Hom}}_A(U, T_1) \xrightarrow{f \circ -} \underline{\text{Hom}}_A(U, L)$$

is an epimorphism. For this, observe that we have a commutative diagram

$$\begin{array}{ccc} \text{Hom}_A(U, T_1) & \xrightarrow{f \circ -} & \text{Hom}_A(U, L) \\ \downarrow & & \downarrow \\ \underline{\text{Hom}}_A(U, T_1) & \xrightarrow{f \circ -} & \underline{\text{Hom}}_A(U, L) \end{array}$$

where the vertical maps are natural epimorphisms. Hence it is enough to show that the map

$$(8) \quad \text{Hom}_A(U, T_1) \xrightarrow{f \circ -} \text{Hom}_A(U, L)$$

is surjective. Applying the functor $\text{Hom}_B(FU, -)$ to the sequence (5) we obtain an exact sequence

$$\text{Hom}_B(FU, FT_1) \xrightarrow{\text{Hom}_B(FU, Ff)} \text{Hom}_B(FU, FT_0) \rightarrow \text{Hom}_B(FU, N) = 0$$

since FU is a projective B -module and N is in $\text{mod } C = (FU)^\perp$. Thus $\text{Hom}_B(FU, Ff)$ is surjective, and also the map (8) is surjective by Proposition 3.5. Hence we have that K belongs to ${}^\perp(\tau U)$ as desired. This shows that $FM \cong N$.

Moreover, we have that

$$0 = \text{Hom}_B(FU, N) \cong \text{Hom}_B(FU, FM) \cong \text{Hom}_A(U, M).$$

Hence M is in \mathcal{U} . This shows that $F : \mathcal{U} \rightarrow \text{mod } C$ is dense, hence F is an equivalence with quasi-inverse G . The fact that this equivalences are exact follows immediately from Proposition 3.5. This concludes the proof of the theorem. \square

Definition 3.9. We say that a full subcategory \mathcal{G} of \mathcal{U} is a *torsion class* in \mathcal{U} if the following holds: Let $0 \rightarrow X \rightarrow Y \rightarrow Z \rightarrow 0$ be an admissible exact sequence in \mathcal{U} , see Remark 3.7:

- (a) If X and Z are in \mathcal{G} , then Y is in \mathcal{G} .
- (b) If Y is in \mathcal{G} , then Z is in \mathcal{G} .

We denote the set of all torsion classes in \mathcal{U} by $\text{tors}\mathcal{U}$. We denote by $\text{f-tors}\mathcal{U}$ the subset of $\text{tors}\mathcal{U}$ consisting of torsion classes which are functorially finite in \mathcal{U} .

Example 3.10. If A is hereditary and U a basic partial-tilting A -module then by [14] the algebra C is hereditary and Theorem 3.8 specializes to a well-known result from *op.cit.*.

The following corollary is an immediate consequence of Theorem 3.8.

Corollary 3.11. *The following holds:*

- (a) *The functors F and G induce mutually inverse bijections between $\text{tors}\mathcal{U}$ and $\text{tors}C$.*
- (b) *These bijections restrict to bijections between $\text{f-tors}\mathcal{U}$ and $\text{f-tors}C$.*
- (c) *These bijections above are isomorphisms of partially ordered sets.*

Proof. It is shown in Theorem 3.8 that F and G give equivalences of exact categories between \mathcal{U} and $\text{mod}C$. Since the notion of torsion class depends only on the exact structure of the category, see Definition 3.9, part (a) follows. Now (b) and (c) are clear. \square

3.2. Reduction of torsion classes and τ -tilting modules. Given two subcategories \mathcal{X} and \mathcal{Y} of $\text{mod}A$ we denote by $\mathcal{X} * \mathcal{Y}$ the full subcategory of $\text{mod}A$ induced by all A -modules M such that there exist a short exact sequence

$$0 \rightarrow X \rightarrow M \rightarrow Y \rightarrow 0$$

with X in \mathcal{X} and Y in \mathcal{Y} . Obviously we have $\mathcal{X}, \mathcal{Y} \subseteq \mathcal{X} * \mathcal{Y}$. The following two results give us reductions at the level of torsion pairs.

Theorem 3.12. *With the hypotheses of Setting 3.1, we have order-preserving bijections*

$$\{\mathcal{T} \in \text{tors}A \mid \text{Fac}U \subseteq \mathcal{T} \subseteq {}^\perp(\tau U)\} \xrightarrow{\text{red}} \text{tors}\mathcal{U} \xrightarrow{F} \text{tors}C$$

where red is given by $\text{red}(\mathcal{T}) := \mathcal{T} \cap U^\perp$ with inverse $\text{red}^{-1}(\mathcal{G}) := (\text{Fac}U) * \mathcal{G}$, and F is given in Corollary 3.11.

The situation of Theorem 3.12 is illustrated in Figure 3.1. Also, the following diagram is helpful to visualize this reduction procedure:

$$\begin{array}{ccc} {}^\perp(\tau U) & \longmapsto & {}^\perp(\tau U) \cap U^\perp = \mathcal{U} \\ \cup \mid & & \cup \mid \\ \mathcal{T} & \longmapsto & \mathcal{T} \cap U^\perp \\ \cup \mid & & \cup \mid \\ \text{Fac}U & \longmapsto & (\text{Fac}U) \cap U^\perp = \{0\} \end{array}$$

Moreover, we have the following bijections:

Theorem 3.13. *The bijections of Theorem 3.12 restrict to order-preserving bijections*

$$\{\mathcal{T} \in \text{f-tors}A \mid \text{Fac}U \subseteq \mathcal{T} \subseteq {}^\perp(\tau U)\} \xrightarrow{\text{red}} \text{f-tors}\mathcal{U} \xrightarrow{F} \text{f-tors}C.$$

For readability purposes, the proofs of Theorems 3.12 and 3.13 are given in Section 3.3. First we use them to establish the bijection between $s\tau\text{-tilt}_U A$ and $s\tau\text{-tilt}C$.

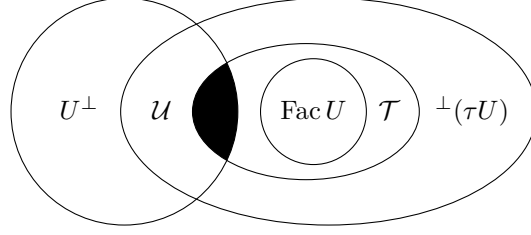

FIGURE 3.1. Reduction of torsion classes in $\text{mod } A$ with respect to $\text{Fac } U$, see Theorems 3.12 and 3.13.

Recall that the torsion pair $(\text{Fac } U, U^\perp)$ gives functors $t : \text{mod } A \rightarrow \text{Fac } U$ and $f : \text{mod } A \rightarrow U^\perp$ and natural transformations $t \rightarrow 1_{\text{mod } A} \rightarrow f$ such that the sequence

$$(9) \quad 0 \rightarrow tM \rightarrow M \rightarrow fM \rightarrow 0$$

is exact for each A -module M . The sequence (9) is called a *canonical sequence*, and the functor t is called the *idempotent radical* associated to the torsion pair $(\text{Fac } U, U^\perp)$. Any short exact sequence $0 \rightarrow L \rightarrow M \rightarrow N \rightarrow 0$ such that L is in $\text{Fac } U$ and N is in U^\perp is isomorphic to the canonical sequence of M , see [4, Prop. VI.1.5]. Note that since ${}^\perp(\tau U)$ is closed under factor modules we have

$$(10) \quad f({}^\perp(\tau U)) \subseteq \mathcal{U}.$$

Proposition 3.14. *Let \mathcal{T} be a functorially finite torsion class in $\text{mod } A$. Then $fP(\mathcal{T})$ is Ext-projective in $\mathcal{T} \cap U^\perp$ and for every A -module N which is Ext-projective in $\mathcal{T} \cap U^\perp$ we have $M \in \text{add}(fP(\mathcal{T}))$.*

Proof. Applying the functor $\text{Hom}_A(-, N)$ to (9), for any N in $\mathcal{T} \cap U^\perp$, we have an exact sequence

$$0 = \text{Hom}_A(tP(\mathcal{T}), N) \rightarrow \text{Ext}_A^1(fP(\mathcal{T}), N) \rightarrow \text{Ext}_A^1(P(\mathcal{T}), N) = 0$$

This shows that $fP(\mathcal{T})$ is Ext-projective in $\mathcal{T} \cap U^\perp$.

Now let N be Ext-projective in $\mathcal{T} \cap U^\perp$. Since $N \in \mathcal{T}$, by Proposition 2.1(e) there exist a short exact sequence $0 \rightarrow L \rightarrow M \rightarrow N \rightarrow 0$ with $M \in \text{add}(P(\mathcal{T}))$ and $L \in \mathcal{T}$. Since $fN = N$ as $N \in U^\perp$, by the functoriality of f we have a commutative diagram with exact rows:

$$\begin{array}{ccccccccc} 0 & \longrightarrow & L & \longrightarrow & M & \xrightarrow{f} & N & \longrightarrow & 0 \\ & & \downarrow & & \downarrow & & \parallel & & \\ 0 & \longrightarrow & K := \text{Ker } ff & \longrightarrow & fM & \xrightarrow{ff} & fN = N & \longrightarrow & 0 \end{array}$$

As the map $M \rightarrow fM$ is surjective and the map $N \rightarrow fN$ is bijective, by the snake lemma we have that the map $L \rightarrow K$ is surjective. Thus, since $L \in \mathcal{T}$, we have that K also belongs to \mathcal{T} . Moreover, K is a submodule of $fM \in U^\perp$, hence K is also in U^\perp . Since N is Ext-projective in $\mathcal{T} \cap U^\perp$ and we have $K \in \mathcal{T} \cap U^\perp$, the lower sequence splits. Thus $N \in \text{add}(fP(\mathcal{T}))$. \square

We are ready to state the main result of this article, which gives the procedure for τ -tilting reduction.

Theorem 3.15. *With the hypotheses of Setting 3.1, we have an order-preserving bijection*

$$\text{red} : s\tau\text{-tilt}_U A \longrightarrow s\tau\text{-tilt } C$$

given by $M \mapsto F(\text{f}M)$ with inverse $N \mapsto P((\text{Fac } U) * G(\text{Fac } N))$. In particular, $s\tau$ -tilt C can be embedded as an interval in $s\tau$ -tilt A .

Proof. By Theorems 2.11 and 3.13 we have a commutative diagram

$$\begin{array}{ccc} \{\mathcal{T} \in \text{f-tors } A \mid \text{Fac } U \subseteq \mathcal{T} \subseteq {}^\perp(\tau U)\} & \longrightarrow & \text{f-tors } C \\ \uparrow & & \downarrow \\ s\tau\text{-tilt}_U A & \dashrightarrow & s\tau\text{-tilt } C \end{array}$$

in which arrow is a bijection, and where the dashed arrow is given by $M \mapsto P((\text{Fac } M) \cap U^\perp)$ and the inverse is given by $N \mapsto P((\text{Fac } U) * G(\text{Fac } N))$. Hence to prove the theorem we only need to show that for any $M \in s\tau\text{-tilt}_U A$ we have $P(F(\text{Fac } M \cap U^\perp)) = F(\text{f}M)$. Indeed, it follows from Proposition 3.14 that $\text{f}M$ is the Ext-progenerator of $(\text{Fac } M) \cap U^\perp$; and since F is an exact equivalence, see Theorem 3.8, we have that $F(\text{f}M)$ is the Ext-progenerator of $F(\text{Fac } M \cap U^\perp)$ which is exactly what we needed to show. \square

Corollary 3.16. *The bijection in Theorem 3.15 is compatible with mutation of support τ -tilting modules.*

Proof. It is shown in [1, Cor. 2.31] that the exchange graph of $s\tau$ -tilt A coincides with the Hasse diagram of $s\tau$ -tilt A . Since τ -tilting reduction preserves the partial order in f-tors (and hence in $s\tau$ -tilt) the claim follows. \square

As a special case of Theorem 3.15 we obtain an independent proof of [1, Thm. 2.17].

Corollary 3.17. *Every almost-complete support τ -tilting A -module U is the direct summand of exactly two support τ -tilting A -modules: $P(\text{Fac } U)$ and T_U .*

Proof. Let U be an almost complete support τ -tilting A -module. Clearly, we have $\{P(\text{Fac } U), T_U\} \subseteq s\tau\text{-tilt}_U A$. On the other hand, $|U| = |A| - 1 = |T_U| - 1$ and thus $|C| = 1$, see Setting 3.1. By Theorem 3.15 we have a bijection between $s\tau\text{-tilt}_U A$ and $s\tau\text{-tilt } C$, and since $|C|=1$ we have that $s\tau\text{-tilt } C = \{0, C\}$, see [1, Ex. 6.1]. Thus $|s\tau\text{-tilt}_U A| = |s\tau\text{-tilt } C| = 2$ and we have the assertion. \square

For a finite dimensional algebra A let $\text{s-tilt } A$ be the set of (isomorphism classes of) basic support tilting A -modules and, if U is a partial-tilting A -module, let $\text{s-tilt}_U A$ be the subset of $\text{s-tilt } A$ defined by

$$\text{s-tilt}_U A := \{M \in \text{s-tilt } A \mid U \in \text{add } M\}.$$

If we restrict ourselves to hereditary algebras we obtain the following improvement of [17, Thm. 3.2].

Corollary 3.18. *Let A be a hereditary algebra. With the hypotheses of Setting 3.1, we have the following:*

- (a) *The algebra C is hereditary.*
- (b) *There is an order-preserving bijection*

$$\text{red} : \text{s-tilt}_U A \longrightarrow \text{s-tilt } C$$

$$\text{given by } M \mapsto F(\text{f}M) \text{ with inverse } N \mapsto P((\text{Fac } U) * G(\text{Fac } N)).$$

Proof. Since A is hereditary, the τ -rigid module U is a partial-tilting module. Moreover, as explained in Example 3.10 we have that C is also a hereditary algebra. Then by Proposition 2.9 we have $s\tau\text{-tilt}_U A = \text{s-tilt}_U A$ and $s\tau\text{-tilt } C = \text{s-tilt } C$. Then the claim follows from Theorem 3.15. \square

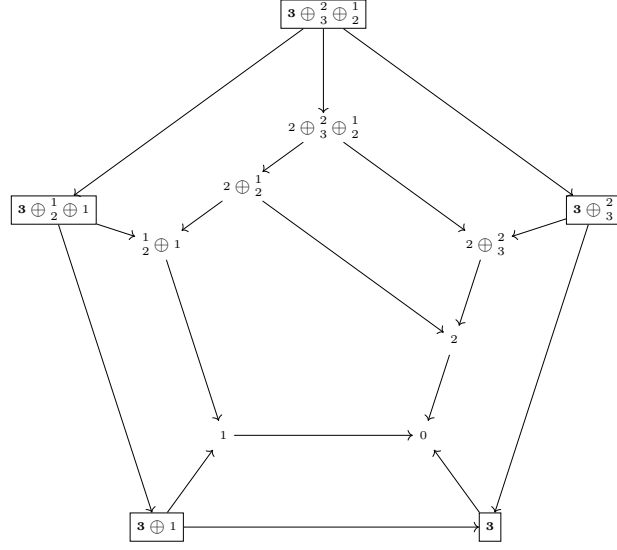

FIGURE 3.2. Embedding of $s\tau$ -tilt C in $Q(s\tau$ -tilt A), see Example 3.19.

We conclude this section with some examples illustrating our results.

Example 3.19. Let A be the algebra given by the quiver $3 \xleftarrow{y} 2 \xleftarrow{x} 1$ with the relation $xy = 0$, see [1, Ex. 6.4]. Consider the support τ -tilting A -module $U = P_3$. Then

$$U = {}^\perp(\tau U) \cap U^\perp = (\text{mod } A) \cap U^\perp = U^\perp.$$

Moreover, the Bongartz completion of U is given by $T = P_1 \oplus P_2 \oplus P_3$, which is the basic progenerator of ${}^\perp(\tau U) = \text{mod } A$. Hence $C = \text{End}_A(P_1 \oplus P_2) \cong k(\bullet \leftarrow \bullet)$, see Example 2.17. We may visualize this in the Auslander-Reiten quiver of $\text{mod } A$, where each A -module is represented by its radical filtration:

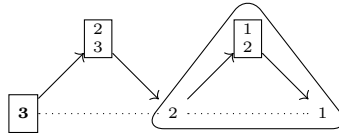

The indecomposable summands of T are indicated with rectangles and U is enclosed in a triangle. Note that U is equivalent to $\text{mod } C$ as shown in Theorem 3.8.

By Theorem 3.15 we have that $s\tau$ -tilt C can be embedded as an interval in $s\tau$ -tilt A . We have indicated this embedding in $Q(s\tau$ -tilt A) in Figure 3.2 by enclosing the image of $s\tau$ -tilt C in rectangles.

Example 3.20. Let A be the preprojective algebra of Dynkin type A_3 , i.e. the algebra given by the quiver

$$3 \begin{array}{c} \xleftarrow{x_2} \\ \xrightarrow{y_2} \end{array} 2 \begin{array}{c} \xleftarrow{x_1} \\ \xrightarrow{y_1} \end{array} 1$$

with relations $x_1y_1 = 0$, $y_2x_2 = 0$ and $y_1x_1 = x_2y_2$.

Let $U = \begin{smallmatrix} 2 \\ 1 \end{smallmatrix}$, then U is τ -rigid and not a support τ -tilting A -module. The Bongartz completion of U is given by $T = P_1 \oplus P_2 \oplus \begin{smallmatrix} 2 \\ 1 \end{smallmatrix} = \begin{smallmatrix} 1 \\ 2 \\ 3 \end{smallmatrix} \oplus \begin{smallmatrix} 2 \\ 1 \\ 3 \end{smallmatrix} \oplus \begin{smallmatrix} 2 \\ 1 \end{smallmatrix}$; hence C is isomorphic to the path algebra given by the quiver

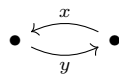

with the relations $xy = 0$ and $yx = 0$, that is C is isomorphic to the preprojective algebra of type A_2 . In this case ${}^\perp(\tau U)$ consists of all A -modules M such that $\tau U = S_3$ is not a direct summand of $\text{top } M$. On the other hand, it is easy to see that the only indecomposable A -modules in ${}^\perp(\tau U)$ which do not belong to U^\perp are U, P_2, S_2 and $\frac{1}{2}$. We can visualize this in the Auslander-Reiten quiver of $\text{mod } A$ as follows (note that the dashed edges are to be identified to form a Möbius strip):

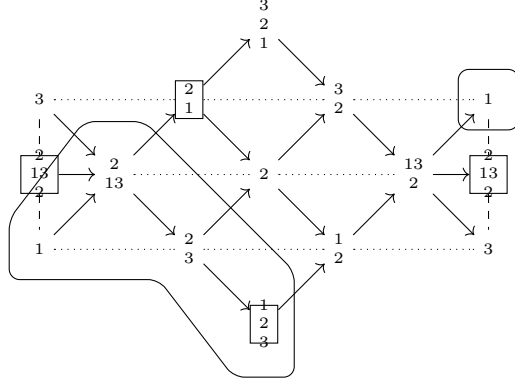

The indecomposable summands of T are indicated with rectangles and U is encircled. Note that U is equivalent to $\text{mod } C$ as shown in Theorem 3.8. By Theorem 3.15 we have that $s\tau$ -tilt C can be embedded as an interval in $s\tau$ -tilt A . We have indicated this embedding in $Q(s\tau\text{-tilt } A)$ in Figure 3.3 by enclosing the image of $s\tau$ -tilt C in rectangles.

Example 3.21. Let A be the algebra given by the path algebra of the quiver

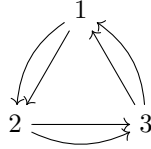

modulo the ideal generated by all paths of length two.

Let $U = \begin{smallmatrix} 11 \\ 222 \end{smallmatrix}$. The Bongartz completion of U is given by $T = P_1 \oplus \begin{smallmatrix} 11 \\ 222 \end{smallmatrix} \oplus P_3 = \begin{smallmatrix} 1 \\ 22 \end{smallmatrix} \oplus \begin{smallmatrix} 11 \\ 222 \end{smallmatrix} \oplus \begin{smallmatrix} 3 \\ 11 \end{smallmatrix}$; hence $C \cong k \times k$. It is easy to see that $Q(s\tau\text{-tilt } C)$ is given by the quiver

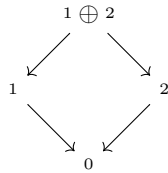

By Theorem 3.15 we have that $s\tau$ -tilt C can be embedded as an interval in $s\tau$ -tilt A . We have indicated this embedding in $Q(s\tau\text{-tilt } A)$ in Figure 3.4 by drawing $Q(s\tau\text{-tilt } C)$ with double arrows.

3.3. Proof of the main theorems. We begin with the proof of Theorem 3.12. The following proposition shows that the map $\mathcal{T} \mapsto \mathcal{T} \cap U^\perp$ in Theorem 3.12 is well defined.

Proposition 3.22. *Let \mathcal{T} be a torsion class in $\text{mod } A$ such that $\text{Fac } U \subseteq \mathcal{T} \subseteq {}^\perp(\tau U)$. Then the following holds:*

- (a) $\mathcal{T} \cap U^\perp$ is in $\text{tors } \mathcal{U}$.
- (b) $\mathcal{T} \cap U^\perp = \text{f}\mathcal{T}$.

If in addition \mathcal{T} is functorially finite in $\text{mod } A$, then we have:

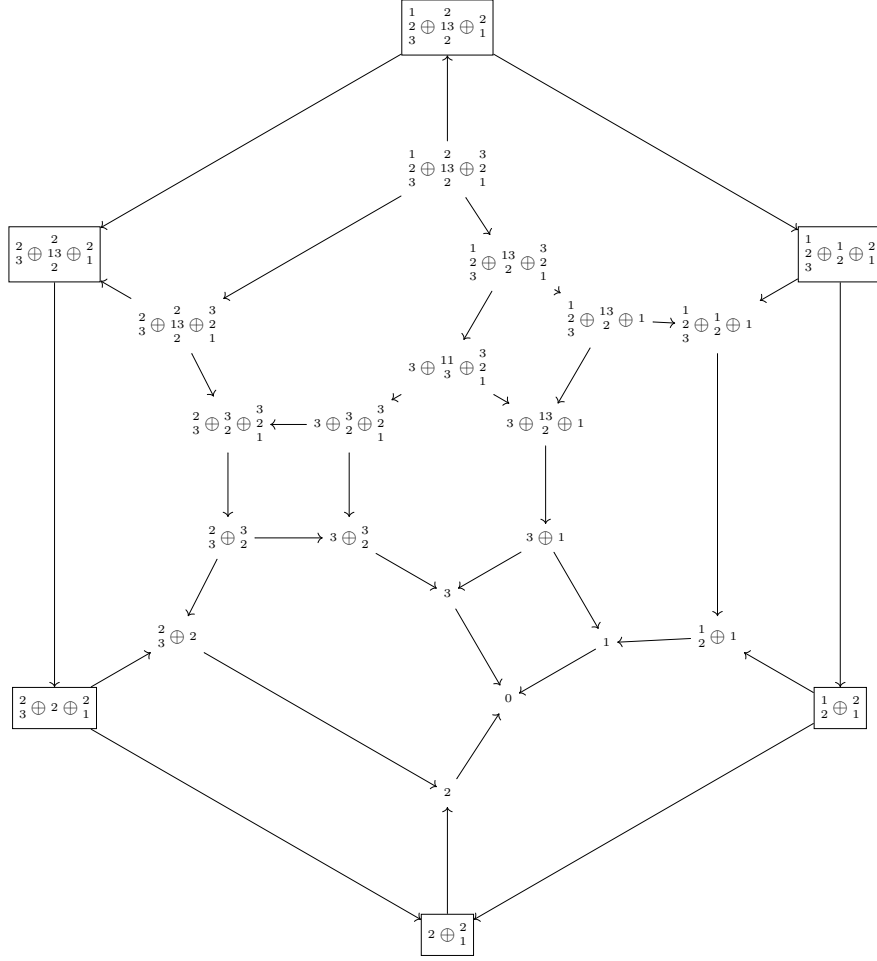
 FIGURE 3.3. Embedding of $s\tau$ -tilt C in $Q(s\tau$ -tilt A), see Example 3.20.

- (c) $\mathcal{T} \cap U^\perp = \text{Fac}(fP(\mathcal{T})) \cap U^\perp$.
 (d) $F(\mathcal{T} \cap U^\perp)$ is in f -tors C .

Proof. (a) $\mathcal{T} \cap U^\perp$ is closed under extensions since both \mathcal{T} and U^\perp are closed under extensions in $\text{mod } A$. Now let $0 \rightarrow L \rightarrow M \rightarrow N \rightarrow 0$ be a short exact sequence in $\text{mod } A$ with terms in \mathcal{U} . If $M \in \mathcal{T}$, then $N \in \mathcal{T}$ since \mathcal{T} is closed under factor modules. Thus $N \in \mathcal{T} \cap \mathcal{U} = \mathcal{T} \cap U^\perp$. This shows that $\mathcal{T} \cap U^\perp$ is a torsion class in \mathcal{U} .

(b) Since \mathcal{T} is closed under factor modules in $\text{mod } A$ we have that $f\mathcal{T} \subseteq \mathcal{T} \cap U^\perp$, hence we only need to show the reverse inclusion. Let $M \in \mathcal{T} \cap U^\perp$. In particular we have that $M \in U^\perp$, hence $fM = M$ and the claim follows.

(c) Since $\text{Fac}(fP(\mathcal{T})) \subseteq \mathcal{T}$, we have that $\text{Fac}(fP(\mathcal{T})) \cap U^\perp \subseteq \mathcal{T} \cap U^\perp$. Now we show the opposite inclusion. Let M be in $\mathcal{T} \cap U^\perp$, then there is an epimorphism $f : X \rightarrow M$ with X in $\text{add}(P(\mathcal{T}))$. Since there are no non-zero morphisms from $\text{Fac } U$ to U^\perp we have a commutative diagram

The following lemma gives canonical sequences in \mathcal{U} .

Lemma 3.24. *Let \mathcal{G} be a torsion class in \mathcal{U} . Then there exist functors $t_{\mathcal{G}} : \mathcal{U} \rightarrow \mathcal{G}$ and $f_{\mathcal{G}} : \mathcal{U} \rightarrow \mathcal{G}^{\perp} \cap \mathcal{U}$ and natural transformations $t_{\mathcal{G}} \rightarrow 1_{\mathcal{U}} \rightarrow f_{\mathcal{G}}$ such that the sequence*

$$0 \rightarrow t_{\mathcal{G}}M \rightarrow M \rightarrow f_{\mathcal{G}}M \rightarrow 0$$

is exact in $\text{mod } A$ for each M in \mathcal{U} .

Proof. Since $(F\mathcal{G}, F(\mathcal{G}^{\perp} \cap \mathcal{U}))$ is a torsion pair in $\text{mod } C$ by Theorem 3.8, we have associated canonical sequences in $\text{mod } C$. Applying the functor G , we get the desired functors. \square

The following proposition shows that the map $\mathcal{G} \mapsto (\text{Fac } U) * \mathcal{G}$ in Theorem 3.13 is well-defined.

Proposition 3.25. *Let \mathcal{G} be in $\text{tors } \mathcal{U}$. Then $(\text{Fac } U) * \mathcal{G}$ is a torsion class in $\text{mod } A$ such that $\text{Fac } U \subseteq (\text{Fac } U) * \mathcal{G} \subseteq {}^{\perp}(\tau U)$.*

Proof. First, it is clear that $\text{Fac } U \subseteq (\text{Fac } U) * \mathcal{G} \subseteq {}^{\perp}(\tau U)$ since \mathcal{G} and $\text{Fac } U$ are subcategories of ${}^{\perp}(\tau U)$ and ${}^{\perp}(\tau U)$ is closed under extensions.

Now, let us show that $(\text{Fac } U) * \mathcal{G}$ is closed under factor modules. Let M be in $(\text{Fac } U) * \mathcal{G}$, so by Lemma 3.23 we have that fM is in \mathcal{G} , and let $f : M \rightarrow N$ be an epimorphism. We have a commutative diagram

$$\begin{array}{ccccccc} 0 & \longrightarrow & tM & \longrightarrow & M & \longrightarrow & fM & \longrightarrow & 0 \\ & & \downarrow t_f & & \downarrow f & & \downarrow f_f & & \\ 0 & \longrightarrow & tN & \longrightarrow & N & \longrightarrow & fN & \longrightarrow & 0 \\ & & & & \downarrow & & \downarrow & & \\ & & & & 0 & & 0 & & \end{array}$$

with exact rows and columns. Since $fM \in \mathcal{G} \subseteq {}^{\perp}(\tau U)$, we have that $fN \in {}^{\perp}(\tau U)$. Thus $fN \in {}^{\perp}(\tau U) \cap U^{\perp} = \mathcal{U}$. Since fM belong to \mathcal{G} which is a torsion class in \mathcal{U} , we have that $fN \in \mathcal{G}$. Finally, since $tN \in \text{Fac } U$ we have that $N \in (\text{Fac } U) * \mathcal{G}$. The claim follows.

To show that $(\text{Fac } U) * \mathcal{G}$ is closed under extensions it is sufficient to show that $\mathcal{G} * \text{Fac } U \subseteq (\text{Fac } U) * \mathcal{G}$ since this implies

$$\begin{aligned} ((\text{Fac } U) * \mathcal{G}) * ((\text{Fac } U) * \mathcal{G}) &= (\text{Fac } U) * (\mathcal{G} * (\text{Fac } U)) * \mathcal{G} \\ &\subseteq (\text{Fac } U) * (\text{Fac } U) * \mathcal{G} * \mathcal{G} = (\text{Fac } U) * \mathcal{G} \end{aligned}$$

by the associativity of the operation $*$. For this, let $0 \rightarrow N \rightarrow M \rightarrow L \rightarrow 0$ be a short exact sequence with N in \mathcal{G} and L in $\text{Fac } U$. We only have to show that $fM \in \mathcal{G}$, or equivalently that $f_{\mathcal{G}}(fM) = 0$. Since $N \in \mathcal{G}$ and $f_{\mathcal{G}}(fM) \in \mathcal{G}^{\perp}$ we have $\text{Hom}_A(N, f_{\mathcal{G}}(fM)) = 0$. Also, $\text{Hom}_A(L, f_{\mathcal{G}}(fM)) = 0$ since $L \in \text{Fac } U$ and $f_{\mathcal{G}}(fM) \in U^{\perp}$. Thus we have $\text{Hom}_A(M, f_{\mathcal{G}}(fM)) = 0$. But $f_{\mathcal{G}}(fM)$ is a factor module of M so we have that $f_{\mathcal{G}}(fM) = 0$. Thus $fM = t_{\mathcal{G}}(fM)$ belongs to \mathcal{G} . \square

Now we give the proof Theorem 3.12.

Proof of Theorem 3.12. By Corollary 3.11 we have that the functors F and G induce mutually inverse bijections between $\text{tors } \mathcal{U}$ and $\text{tors } C$. It follows from Proposition 3.22(a) that the correspondence $\mathcal{T} \mapsto \mathcal{T} \cap U^{\perp}$ gives a well defined map

$$\{\mathcal{T} \in \text{tors } A \mid \text{Fac } U \subseteq \mathcal{T} \subseteq {}^{\perp}(\tau U)\} \longrightarrow \text{tors } \mathcal{U}.$$

On the other hand, it follows from Proposition 3.25 that the association $\mathcal{G} \mapsto (\text{Fac } U) * \mathcal{G}$ gives a well defined map

$$\text{tors } \mathcal{U} \longrightarrow \{\mathcal{T} \in \text{tors } A \mid \text{Fac } U \subseteq \mathcal{T} \subseteq {}^\perp(\tau U)\}.$$

It remains to show that the maps

$$\mathcal{T} \mapsto \mathcal{T} \cap U^\perp \quad \text{and} \quad \mathcal{G} \mapsto \text{Fac } U * \mathcal{G}$$

are inverse of each other. Let \mathcal{T} be a torsion class in $\text{mod } A$ such that $\text{Fac } U \subseteq \mathcal{T} \subseteq {}^\perp(\tau U)$. Since \mathcal{T} is closed under extensions, we have that $(\text{Fac } U) * (\mathcal{T} \cap U^\perp) \subseteq \mathcal{T}$. Thus we only need to show the opposite inclusion. Let M be in \mathcal{T} , then we have an exact sequence

$$0 \rightarrow \text{t}M \rightarrow M \rightarrow \text{f}M \rightarrow 0$$

with $\text{t}M \in \text{Fac } U$ and $\text{f}M$ in $\mathcal{T} \cap U^\perp$ since \mathcal{T} is closed under factor modules. Thus $M \in (\text{Fac } U) * (\mathcal{T} \cap U^\perp)$ holds and the claim follows.

On the other hand, let \mathcal{G} be a torsion class in \mathcal{U} . It is clear that $\mathcal{G} \subseteq ((\text{Fac } U) * \mathcal{G}) \cap U^\perp$, so we only need to show the opposite inclusion. But if M is in $((\text{Fac } U) * \mathcal{G}) \cap U^\perp$, then $M \in U^\perp$ implies that $M \cong \text{f}M$. Moreover, by Lemma 3.23 we have that $M \cong \text{f}M$ belongs to \mathcal{G} . This finishes the proof of the theorem. \square

Now we begin to prove Theorem 3.13. For this we need the following technical result:

Proposition 3.26. [20, Prop 5.33] *Let \mathcal{X} and \mathcal{Y} be covariantly finite subcategories of $\text{mod } A$. Then $\mathcal{X} * \mathcal{Y}$ is also covariantly finite in $\text{mod } A$.*

We also need the following observation.

Lemma 3.27. *\mathcal{U} is covariantly finite in ${}^\perp(\tau U)$.*

Proof. Let M be in ${}^\perp(\tau U)$ and consider the canonical sequence

$$0 \rightarrow \text{t}M \rightarrow M \xrightarrow{f} \text{f}M \rightarrow 0.$$

Then $\text{f}M$ is in \mathcal{U} by (10) and clearly f is a left \mathcal{U} -approximation (mind that $\mathcal{U} \subseteq U^\perp$). Thus \mathcal{U} is covariantly finite in ${}^\perp(\tau U)$ as required. \square

The following proposition shows that the map $\mathcal{G} \mapsto (\text{Fac } U) * \mathcal{G}$ in Theorem 3.13 preserves functorial finiteness, and thus is well defined.

Proposition 3.28. *Let \mathcal{G} be in $\text{f-tors } \mathcal{U}$. Then $(\text{Fac } U) * \mathcal{G}$ is a functorially finite torsion class in $\text{mod } A$ such that $\text{Fac } U \subseteq (\text{Fac } U) * \mathcal{G} \subseteq {}^\perp(\tau U)$.*

Proof. By Proposition 3.25, we only need to show that $(\text{Fac } U) * \mathcal{G}$ is covariantly finite in $\text{mod } A$. Since $\text{Fac } U$ is covariantly finite in $\text{mod } A$, see Proposition 2.1(b), by Proposition 3.26 it is enough to show that \mathcal{G} is covariantly finite in $\text{mod } A$. By Lemma 3.27 we have that \mathcal{U} is covariantly finite in ${}^\perp(\tau U)$. Since \mathcal{G} is covariantly finite in \mathcal{U} and ${}^\perp(\tau U)$ is covariantly finite in $\text{mod } A$, see Proposition 2.1(b), we have that \mathcal{G} is covariantly finite in $\text{mod } A$. \square

We are ready to give the proof of Theorem 3.13.

Proof of Theorem 3.13. We only need to show that the bijections in Theorem 3.12 preserve functorial finiteness. But this follows immediately from Proposition 3.22(d) and Proposition 3.28. The theorem follows. \square

4. COMPATIBILITY WITH OTHER TYPES OF REDUCTION

Let A be a finite dimensional algebra. Then support τ -tilting A -modules are in bijective correspondence with the so-called two-term silting complexes in $K^b(\text{proj } A)$, see [1, Thm. 3.2].

On the other hand, if A is a 2-Calabi-Yau-tilted algebra from a 2-Calabi-Yau category \mathcal{C} , then there is a bijection between $s\tau$ -tilt A and the set of isomorphism classes of basic cluster-tilting objects in \mathcal{C} , see [1, Thm. 4.1].

Reduction techniques were established (in greater generality) in [22, Thm. 4.9] for cluster-tilting objects and for silting objects in [3, Thm. 2.37] for a special case and in [21] for the general case. The aim of this section is to show that these reductions are compatible with τ -tilting reduction as established in Section 3.

Given two subcategories \mathcal{X} and \mathcal{Y} of a triangulated category \mathcal{T} , we write $\mathcal{X} * \mathcal{Y}$ for the full subcategory of \mathcal{T} consisting of all objects $Z \in \mathcal{T}$ such that there exists a triangle

$$X \rightarrow Z \rightarrow Y \rightarrow X[1]$$

with $X \in \mathcal{X}$ and $Y \in \mathcal{Y}$. For objects X and Y in \mathcal{T} we define $X * Y := (\text{add } X) * (\text{add } Y)$.

4.1. Silting reduction. Let \mathcal{T} be a Krull-Schmidt triangulated category and S an object in \mathcal{T} . Following [3, Def. 2.1], we say that M is a *presilting object* in \mathcal{T} if

$$\text{Hom}_{\mathcal{T}}(M, M[i]) = 0 \quad \text{for all } i > 0.$$

We call S a *silting object* if moreover $\text{thick}(S) = \mathcal{T}$, where $\text{thick}(S)$ is the smallest triangulated subcategory of \mathcal{T} which contains S and is closed under direct summands and isomorphisms. We denote the set of isomorphism classes of all basic silting objects in \mathcal{T} by $\text{silt } \mathcal{T}$.

Let $M, N \in \text{silt } \mathcal{T}$. We write $N \leq M$ if and only if $\text{Hom}_{\mathcal{T}}(M, N[i]) = 0$ for each $i > 0$. Then \leq is a partial order in $\text{silt } \mathcal{T}$, see [3, Thm. 2.11].

Setting 4.1. We fix a k -linear, Hom-finite, Krull-Schmidt triangulated category \mathcal{T} with a silting object S , and let

$$A = A_S := \text{End}_{\mathcal{T}}(S).$$

The subset $2_S\text{-silt } \mathcal{T}$ of $\text{silt } \mathcal{T}$ given by

$$2_S\text{-silt } \mathcal{T} := \{M \in \text{silt } \mathcal{T} \mid M \in S * (S[1])\}$$

plays an important role in the sequel. The notation $2_S\text{-silt } \mathcal{T}$ is justified by the following remark.

Remark 4.2. Let A be a finite dimensional algebra and $\mathcal{T} = K^b(\text{proj } A)$. Then A is a silting object in \mathcal{T} . In this case a silting complex M belongs to $2_A\text{-silt } \mathcal{T}$ if and only if M is isomorphic to a complex concentrated in degrees -1 and 0 , *i.e.* if M is a *two-term silting complex*.

Following [3, Sec. 2], we consider the subcategory of \mathcal{T} given by

$$\mathcal{T}^{\leq 0} := \{M \in \mathcal{T} \mid \text{Hom}_{\mathcal{T}}(S, M[i]) = 0 \text{ for all } i > 0\}.$$

We need the following generating properties of silting objects. Recall that a pair $(\mathcal{X}, \mathcal{Y})$ of subcategories of \mathcal{T} is called a *torsion pair* in \mathcal{T} if $\text{Hom}_{\mathcal{T}}(\mathcal{X}, \mathcal{Y}) = 0$ and $\mathcal{T} = \mathcal{X} * \mathcal{Y}$.

Proposition 4.3. [3, Prop. 2.23] *With the hypotheses of Setting 4.1, we have the following:*

$$\begin{aligned}\mathcal{T} &= \bigcup_{\ell \geq 0} S[-\ell] * S[1-\ell] * \cdots * S[\ell], \\ \mathcal{T}^{\leq 0} &= \bigcup_{\ell \geq 0} S * S[1] * \cdots * S[\ell], \\ {}^{\perp}(\mathcal{T}^{\leq 0}) &= \bigcup_{\ell > 0} S[-\ell] * S[1-\ell] * \cdots * S[-1].\end{aligned}$$

Moreover, the pair $({}^{\perp}(\mathcal{T}^{\leq 0}), \mathcal{T}^{\leq 0})$ is a torsion pair in \mathcal{T} .

The following proposition describes 2_S -silt \mathcal{T} in terms of the partial order in silt \mathcal{T} . It is shown in [2, Prop. 2.9] in the case when $\mathcal{T} = K^b(\text{proj } A)$ and $S = A$.

Proposition 4.4. *Let M be an object of \mathcal{T} . Then, $M \in S * S[1]$ if and only if $S[1] \leq M \leq S$.*

Proof. Before starting the proof, let us make the following trivial observation: Given two subcategories \mathcal{X} and \mathcal{Y} of \mathcal{T} , for any object M of \mathcal{T} , we have that $\text{Hom}_{\mathcal{T}}(\mathcal{X} * \mathcal{Y}, M) = 0$ if and only if $\text{Hom}_{\mathcal{T}}(\mathcal{X}, M) = 0$ and $\text{Hom}_{\mathcal{T}}(\mathcal{Y}, M) = 0$.

Now note that we have $M \leq S$ if and only if $\text{Hom}_{\mathcal{T}}(S[-i], M) = 0$ for each $i > 0$, or equivalently by the above observation, $\text{Hom}_{\mathcal{T}}(S[-\ell] * \cdots * S[-1], M) = 0$ for each $\ell > 0$. Thus, by Proposition 4.3 we have that

$$(11) \quad M \leq S \quad \text{if and only if} \quad \text{Hom}_{\mathcal{T}}({}^{\perp}(\mathcal{T}^{\leq 0}), M) = 0$$

or equivalently, since $({}^{\perp}(\mathcal{T}^{\leq 0}), \mathcal{T}^{\leq 0})$ is a torsion pair by Proposition 4.3, $M \in \mathcal{T}^{\leq 0} = (S * S[1]) * \mathcal{T}^{\leq 0}[2]$. By a similar argument, we have that

$$(12) \quad S[1] \leq M \quad \text{if and only if} \quad \text{Hom}_{\mathcal{T}}(M, \mathcal{T}^{\leq 0}[2]) = 0.$$

Then it follows from (11) and (12) that $S[1] \leq M \leq S$ if and only if $M \in S * S[1]$. \square

We need the following result:

Proposition 4.5. [22, Prop. 6.2(3)] *The functor*

$$(13) \quad \overline{(-)} = \text{Hom}_{\mathcal{T}}(S, -) : S * S[1] \rightarrow \text{mod } A$$

induces an equivalence of categories

$$(14) \quad \overline{(-)} : \frac{S * S[1]}{[S[1]]} \longrightarrow \text{mod } A.$$

where $[S[1]]$ is the ideal of \mathcal{T} consisting of morphisms which factor through $\text{add } S[1]$.

Proof. Take $\mathcal{X} = \text{add } S$, $\mathcal{Y} = \text{add } S[1]$ and $\mathcal{Z} = \text{add } S$ in [22, Prop. 6.2(3)]. \square

In view of Proposition 4.5, for every $M, N \in S * S[1]$ we have a natural isomorphism

$$\frac{\text{Hom}_{\mathcal{T}}(M, N)}{[S[1]](M, N)} \cong \text{Hom}_A(\overline{M}, \overline{N}).$$

Setting 4.6. From now on, we fix a presilting object U in \mathcal{T} contained in $S * S[1]$. For simplicity, we assume that U has no non-zero direct summands in $\text{add } S[1]$. We are interested in the subset of 2_S -silt \mathcal{T} given by

$$2_S\text{-silt}_U \mathcal{T} := \{M \in 2_S\text{-silt } \mathcal{T} \mid U \in \text{add } S\}.$$

The following theorem is similar to [1, Thm. 3.2].

Theorem 4.7. [19, Thm. 4.5] *With the hypotheses of Setting 4.1, the functor (13) induces an order-preserving bijection*

$$\overline{(-)} : 2_S\text{-silt } \mathcal{T} \longrightarrow s\tau\text{-tilt } A$$

which induces a bijection

$$\overline{(-)} : 2_{S\text{-silt}_U} \mathcal{T} \longrightarrow s\tau\text{-tilt}_{\overline{\mathcal{T}}} A.$$

Silting reduction was introduced in [3, Thm. 2.37] in a special case and [21] in the general case. We are interested in the following particular situation:

Theorem 4.8. [21] *Let U be a presilting object in \mathcal{T} contained in $S * S[1]$. Then the canonical functor*

$$(15) \quad \mathcal{T} \longrightarrow \mathcal{U} := \frac{\mathcal{T}}{\text{thick}(U)}$$

induces an order-preserving bijection

$$\text{red} : \{M \in \text{silt } \mathcal{T} \mid U \in \text{add } M\} \longrightarrow \text{silt } \mathcal{U}.$$

We need to consider the following analog of Bongartz completion for presilting objects in $S * S[1]$, cf. [12, Sec. 5] and [29, Prop. 6.1].

Definition-Proposition 4.9. [2, Prop. 2.16] *Let $f : U' \rightarrow S[1]$ be a minimal right $(\text{add } U)$ -approximation of $S[1]$ in \mathcal{T} and consider a triangle*

$$(16) \quad S \rightarrow X_U \rightarrow U' \xrightarrow{f} S[1].$$

Then $T_U := X_U \oplus U$ is in $2_S\text{-silt } \mathcal{T}$ and moreover T_U has no non-zero direct summands in $\text{add } S[1]$. We call T_U the *Bongartz completion of U in $S * S[1]$* .

Proof. It is shown in [2, Prop. 2.16] that T_U is a silting object in \mathcal{T} . Moreover, since $\text{Hom}_{\mathcal{T}}(S, S[1]) = 0$ we have

$$T_U \in S * (S * S[1]) = (S * S) * S[1] = S * S[1],$$

hence $T_U \in 2_S\text{-silt } \mathcal{T}$. Finally, since $\text{Hom}_A(S, S[1]) = 0$ and U has no non-zero direct summands in $\text{add } S[1]$, it follows from the triangle (16) that T_U has no non-zero direct summands in $\text{add } S[1]$. \square

We recall that by Proposition 3.2 we have that $s\tau\text{-tilt}_{\overline{\mathcal{T}}} A$ equals the interval

$$\{M \in s\tau\text{-tilt } A \mid P(\text{Fac } \overline{U}) \leq M \leq T_U\} \subseteq s\tau\text{-tilt } A;$$

hence T_U is the unique maximal element in $s\tau\text{-tilt}_{\overline{\mathcal{T}}} A$. The following proposition relates the Bongartz completion T_U of U in $S * S[1]$ with the Bongartz completion $T_{\overline{U}}$ of \overline{U} in $\text{mod } A$.

Proposition 4.10. (a) T_U is the unique maximal element in $2_S\text{-silt}_U \mathcal{T}$.

(b) $\overline{T_U} \cong T_{\overline{U}}$.

Proof. First, note that (b) follows easily from part (a). Indeed, since T_U has no non-zero direct summands in $\text{add } S[1]$, see Definition-Proposition 4.9, we have that $|A| = |S| = |T_U| = |\overline{T_U}|$. By Theorem 4.7 we have that $\overline{T_U}$ is a τ -tilting A -module. Since $P({}^\perp(\tau\overline{U}))$ is the unique maximal element in $s\tau\text{-tilt}_{\overline{\mathcal{T}}} A$, to show part (b), i.e. that $\overline{T_U} \cong P({}^\perp(\tau\overline{U}))$, we only need to show that T_U is the unique maximal element in $2_{S\text{-silt}_U} \mathcal{T}$.

For this, let $M \in 2_{S\text{-silt}_U} \mathcal{T}$ and fix $i > 0$. Applying the functor $\text{Hom}_{\mathcal{T}}(-, M[i])$ to (16) we obtain an exact sequence

$$\text{Hom}_{\mathcal{T}}(U', M[i]) \rightarrow \text{Hom}_{\mathcal{T}}(X_U, M[i]) \rightarrow \text{Hom}_{\mathcal{T}}(S, M[i]).$$

Now, since M is silting and $U' \in \text{add } M$ we have that $\text{Hom}_{\mathcal{T}}(U', M[i]) = 0$ for each $i > 0$. On the other hand, since $M \in S * S[1]$, by Proposition 4.4 we have $\text{Hom}_{\mathcal{T}}(S, M[i]) = 0$ for each $i > 0$. Thus we have $\text{Hom}_{\mathcal{T}}(X_U, M[i]) = 0$ for each $i > 0$. Since $T_U = X_U \oplus U$ we have $\text{Hom}_{\mathcal{T}}(T_U, M[i]) = 0$ for each $i > 0$, hence $M \leq T_U$. The claim follows. \square

From this we can deduce the following result:

Proposition 4.11. *Let $T_U \in 2_S\text{-silt } \mathcal{T}$ be the Bongartz completion of U in $S * S[1]$. Then $T_U \cong S$ in \mathcal{U} and the canonical functor (15) induces an order preserving map*

$$\text{red} : 2_S\text{-silt}_U \mathcal{T} \longrightarrow 2_{T_U}\text{-silt } \mathcal{U}.$$

Proof. By (16) we have that $S \cong T_U$ in $\mathcal{U} = {}^\perp(\tau U) \cap U^\perp$, hence the canonical functor $\mathcal{T} \rightarrow \mathcal{U}$ restricts to a functor $S * S[1] \rightarrow T_U * T_U[1] \subset \mathcal{U}$. The claim now follows from Theorem 4.8. \square

We are ready to state the main theorem of this section. We keep the notation of the above discussion.

Theorem 4.12. *With the hypotheses of Settings 4.1 and 4.6, we have the following:*

- (a) *The algebras $\text{End}_{\mathcal{U}}(T_U)$ and $C = \text{End}_A(\overline{T_U}) / \langle e_{\overline{T_U}} \rangle$ are isomorphic, where $e_{\overline{T_U}}$ is the idempotent corresponding to the projective $\text{End}_A(\overline{T_U})$ -module $\text{Hom}_A(\overline{T_U}, \overline{U})$.*
- (b) *We have a commutative diagram*

$$\begin{array}{ccc} 2_S\text{-silt}_U \mathcal{T} & \xrightarrow{\text{Hom}_{\mathcal{T}}(S, -)} & s\tau\text{-tilt}_{\overline{T_U}} A \\ \text{red} \downarrow & & \downarrow \text{red} \\ 2_{T_U}\text{-silt } \mathcal{U} & \xrightarrow{\text{Hom}_{\mathcal{U}}(T_U, -)} & s\tau\text{-tilt } C \end{array}$$

in which each arrow is a bijection. The vertical maps are given in Proposition 4.11 and Theorem 3.15 respectively.

We begin by proving part (a) of Theorem 4.12. For this we need the following technical result.

Let \mathcal{V} be the subcategory of \mathcal{T} given by

$$\mathcal{V} := \{M \in \mathcal{T} \mid \text{Hom}_{\mathcal{T}}(M, U[i]) = 0 \text{ and } \text{Hom}_{\mathcal{T}}(U, M[i]) = 0 \text{ for each } i > 0\}.$$

Note that if M is an object in $\text{silt}_U \mathcal{T}$ then $M \in \mathcal{V}$. The following theorem allows us to realize \mathcal{U} as a subfactor category of \mathcal{T} .

Theorem 4.13. [21] *The composition of canonical functors $\mathcal{V} \rightarrow \mathcal{T} \rightarrow \mathcal{U}$ induces an equivalence*

$$\frac{\mathcal{V}}{[U]} \cong \mathcal{U}$$

of additive categories. In particular, for every M in \mathcal{V} there is a natural isomorphism

$$\frac{\text{Hom}_{\mathcal{T}}(T_U, M)}{[U](T_U, M)} \cong \text{Hom}_{\mathcal{U}}(T_U, M)$$

Now we can prove the following lemma:

Lemma 4.14. *For each M in \mathcal{V} we have a functorial isomorphism*

$$\frac{\text{Hom}_A(\overline{T_U}, \overline{M})}{[\overline{U}](\overline{T_U}, \overline{M})} \cong \text{Hom}_{\mathcal{U}}(T_U, M).$$

Proof. By (14) we have the following functorial isomorphism

$$\frac{\mathrm{Hom}_A(\overline{T_U}, \overline{M})}{[\overline{U}](\overline{T_U}, \overline{M})} \cong \frac{\frac{\mathrm{Hom}_{\mathcal{C}}(T_U, M)}{[S[1]](T_U, M)}}{[U](T_U, M) + [S[1]](T_U, M)}.$$

We claim that $[S[1]](T_U, M) \subseteq [U](T_U, M)$, or equivalently

$$[S[1]](X_U, M) \subseteq [U](T_U, M)$$

since $T_U = X \oplus U$. Apply the contravariant functor $\mathrm{Hom}_{\mathcal{T}}(-, S[1])$ to the triangle (16) to obtain an exact sequence

$$\mathrm{Hom}_{\mathcal{T}}(U', S[1]) \rightarrow \mathrm{Hom}_{\mathcal{T}}(X_U, S[1]) \rightarrow \mathrm{Hom}_{\mathcal{T}}(S, S[1]) = 0.$$

Hence every morphism $X_U \rightarrow S[1]$ factors through U' , and we have $[S[1]](X_U, M) \subseteq [U](X_U, M)$. Thus by Theorem 4.13 we have isomorphisms

$$\frac{\mathrm{Hom}_A(\overline{T_U}, \overline{M})}{[\overline{U}](\overline{T_U}, \overline{M})} \cong \frac{\mathrm{Hom}_{\mathcal{C}}(T_U, M)}{[U](T_U, M)} \cong \mathrm{Hom}_{\mathcal{U}}(T_U, M),$$

which shows the assertion. \square

Now part (a) of Theorem 4.12 follows by putting $M = T_U$ in Lemma 4.14. In the remainder we prove Theorem 4.12(b).

For $X \in \mathrm{mod} A$ we denote by $0 \rightarrow tX \rightarrow X \rightarrow fX \rightarrow 0$ the canonical sequence of X with respect to the torsion pair $(\mathrm{Fac} \overline{U}, \overline{U}^\perp)$ in $\mathrm{mod} A$.

Proposition 4.15. *For each M in \mathcal{V} there is an isomorphism of \mathcal{C} -modules*

$$\mathrm{Hom}_A(\overline{T_U}, f\overline{M}) \cong \mathrm{Hom}_{\mathcal{U}}(T_U, M)$$

Proof. By Lemma 4.14 it is sufficient to show that

$$\frac{\mathrm{Hom}_A(\overline{T_U}, \overline{M})}{[\overline{U}](\overline{T_U}, \overline{M})} \cong \mathrm{Hom}_A(\overline{T_U}, f\overline{M}).$$

Apply the functor $\mathrm{Hom}_A(\overline{T_U}, -)$ to the canonical sequence

$$0 \rightarrow t\overline{M} \xrightarrow{i} \overline{M} \rightarrow f\overline{M} \rightarrow 0$$

to obtain an exact sequence

$$0 \rightarrow \mathrm{Hom}_A(\overline{T_U}, t\overline{M}) \xrightarrow{i \circ -} \mathrm{Hom}_A(\overline{T_U}, \overline{M}) \rightarrow \mathrm{Hom}_A(\overline{T_U}, f\overline{M}) \rightarrow \mathrm{Ext}_A^1(\overline{T_U}, t\overline{M}) = 0,$$

since $\overline{T_U}$ is Ext-projective in ${}^\perp(\tau\overline{U})$ by Proposition 4.22 and $t\overline{M}$ is in $\mathrm{Fac} \overline{U} \subseteq {}^\perp(\tau\overline{U})$. Thus

$$\mathrm{Hom}_A(\overline{T_U}, f\overline{M}) \cong \frac{\mathrm{Hom}_A(\overline{T_U}, \overline{M})}{i(\mathrm{Hom}_A(\overline{T_U}, t\overline{M}))}.$$

Thus we only have to show the equality $\mathrm{Hom}_A(\overline{T_U}, t\overline{M}) = i([U](\overline{T_U}, t\overline{M}))$. First, $\mathrm{Hom}_A(\overline{T_U}, t\overline{M}) \subseteq i([U](\overline{T_U}, t\overline{M}))$ since i is a right $(\mathrm{Fac} U)$ -approximation of \overline{M} . Next we show the reverse inclusion. It is enough to show that every map $\overline{T_U} \rightarrow t\overline{M}$ factors through $\mathrm{add} \overline{U}$. Let $r : \overline{U}' \rightarrow t\overline{M}$ be a right $(\mathrm{add} \overline{U})$ -approximation. Since $t\overline{M} \in \mathrm{Fac} \overline{U}$ we have a short exact sequence

$$0 \rightarrow \overline{K} \rightarrow \overline{U}' \xrightarrow{r} t\overline{M} \rightarrow 0.$$

Moreover, by Lemma 2.6, we have $\overline{K} \in {}^\perp(\tau\overline{U})$. Apply the functor $\mathrm{Hom}_A(\overline{T_U}, -)$ to the above sequence to obtain an exact sequence

$$\mathrm{Hom}_A(\overline{T_U}, \overline{U}') \rightarrow \mathrm{Hom}_A(\overline{T_U}, t\overline{M}) \rightarrow \mathrm{Ext}_A^1(\overline{T_U}, \overline{K}) = 0.$$

Thus the assertion follows. \square

We are ready to prove Theorem 4.12(b).

Proof of Theorem 4.12(b). Let $M \in 2_S\text{-silt}_U \mathcal{T}$. Then $M \in \mathcal{V}$. We only need to show that $\text{Hom}_U(T_U, M)$ coincides with the τ -tilting reduction of $\overline{M} \in s\tau\text{-tilt } A$ with respect to \overline{U} , which is given by $\text{Hom}_A(\overline{T_U}, \overline{fM})$, see Theorem 3.15. This is shown in Proposition 4.15. \square

Corollary 4.16. *The map*

$$\text{red} : \{M \in 2_S\text{-silt } \mathcal{T} \mid U \in \text{add } M\} \longrightarrow 2_{T_U}\text{-silt } \mathcal{U}.$$

is bijective.

4.2. Calabi-Yau reduction. Let \mathcal{C} be a Krull-Schmidt 2-Calabi-Yau triangulated category. Thus \mathcal{C} is k -linear, Hom-finite and there is a bifunctorial isomorphism

$$\text{Hom}_{\mathcal{C}}(M, N) \cong D \text{Hom}_{\mathcal{C}}(N, M[2])$$

for every $M, N \in \mathcal{C}$, where $D = \text{Hom}_k(-, k)$ is the usual k -duality. Recall that an object T in \mathcal{C} is called *cluster-tilting* if

$$\text{add } T = \{X \in \mathcal{C} \mid \text{Hom}_{\mathcal{C}}(X, T[1]) = 0\}.$$

We denote by $\text{c-tilt } \mathcal{C}$ the set of isomorphism classes of all basic cluster-tilting objects in \mathcal{C} .

Setting 4.17. We fix a Krull-Schmidt 2-Calabi-Yau triangulated category \mathcal{C} with a cluster-tilting object T . Also, we let

$$A = \text{End}_{\mathcal{C}}(T).$$

The algebra A is said to be *2-Calabi-Yau tilted*.

Note that the functor

$$(17) \quad \overline{(-)} = \text{Hom}_{\mathcal{C}}(T, -) : \mathcal{C} \longrightarrow \text{mod } A$$

induces an equivalence of categories

$$(18) \quad \overline{(-)} : \frac{\mathcal{C}}{[T[1]]} \longrightarrow \text{mod } A$$

where $[T[1]]$ is the ideal of \mathcal{C} consisting of morphisms which factor through $\text{add } T[1]$, [24, Prop. 2(c)]. Thus for every $M, N \in \mathcal{C}$ we have a natural isomorphism

$$\text{Hom}_A(\overline{M}, \overline{N}) \cong \frac{\text{Hom}_{\mathcal{C}}(M, N)}{[T[1]](M, N)}.$$

We have the following result:

Theorem 4.18. [1, Thm. 4.1] *With the hypotheses of Setting 4.17, the functor (17) sends rigid object in \mathcal{C} to τ -rigid objects in $\text{mod } A$, and induces a bijection*

$$\overline{(-)} : \text{c-tilt } \mathcal{C} \longrightarrow s\tau\text{-tilt } A$$

which induces a bijection

$$\overline{(-)} : \text{c-tilt}_U \mathcal{C} \longrightarrow s\tau\text{-tilt}_U A.$$

Setting 4.19. From now on we fix a rigid object U in \mathcal{C} , *i.e.* $\text{Hom}_{\mathcal{C}}(U, U[1]) = 0$. To simplify the exposition, we assume that U has no non-zero direct summands in $\text{add } T[1]$ although our results remain true in this case. We are interested in the subset of $\text{c-tilt } \mathcal{C}$ given by

$$\text{c-tilt}_U \mathcal{C} := \{M \in \text{c-tilt } \mathcal{C} \mid U \in \text{add } M\}.$$

Calabi-Yau reduction was introduced in [22, Thm. 4.9]. We are interested in the following particular case:

Theorem 4.20. [22, Sec. 4] *The category \mathcal{U} has the structure of a 2-Calabi-Yau triangulated category and the canonical functor*

$${}^{\perp}(U[1]) \longrightarrow \mathcal{U} := \frac{{}^{\perp}(U[1])}{[U]}$$

induces a bijection

$$\text{red} : \text{c-tilt}_U \mathcal{C} \longrightarrow \text{c-tilt } \mathcal{U}.$$

We need to consider the following analog of Bongartz completion for rigid objects in \mathcal{C} .

Definition-Proposition 4.21. Let $f : U' \rightarrow T[1]$ be a minimal right $(\text{add } U)$ -approximation of $T[1]$ in \mathcal{C} and consider a triangle

$$(19) \quad T \xrightarrow{h} X_U \xrightarrow{g} U' \xrightarrow{f} T[1].$$

Then $T_U := X_U \oplus U$ is cluster-tilting in \mathcal{C} and moreover T_U has no non-zero direct summands in $\text{add } T[1]$. We call T_U the *Bongartz completion of U in \mathcal{C} with respect to T* .

Proof. (i) First we show that T_U is rigid. Our argument is a triangulated version of the proof of [15, Prop. 5.1]. We give the proof for the convenience of the reader.

Apply the functor $\text{Hom}_{\mathcal{C}}(U, -)$ to the triangle (19) to obtain an exact sequence

$$\text{Hom}_{\mathcal{C}}(U, U') \xrightarrow{f \circ -} \text{Hom}_{\mathcal{C}}(U, T[1]) \rightarrow \text{Hom}_{\mathcal{C}}(U, X_U[1]) \rightarrow \text{Hom}_{\mathcal{C}}(U, U'[1]) = 0.$$

But $f : U' \rightarrow T[1]$ is a right $(\text{add } U)$ -approximation of $T[1]$, thus $f \circ -$ is an epimorphism and we have $\text{Hom}_{\mathcal{C}}(U, X_U[1]) = 0$ and, by the 2-Calabi-Yau property, $\text{Hom}_{\mathcal{C}}(X_U, U[1]) = 0$. It remains to show that $\text{Hom}_{\mathcal{C}}(X_U, X_U[1]) = 0$. For this let $a : X_U \rightarrow X_U[1]$ be an arbitrary morphism. Since $\text{Hom}_{\mathcal{C}}(X_U, U'[1]) = 0$ there exists a morphism $h : X_U \rightarrow T[1]$ such that the following diagram commutes:

$$\begin{array}{ccccccc} T & \longrightarrow & X_U & \xrightarrow{g} & U' & \longrightarrow & T[1] \\ & & \searrow h & & \downarrow a & & \\ & & & & X_U[1] & \longrightarrow & U'[1] \\ & & & & \uparrow h[1] & & \\ U' & \longrightarrow & T[1] & \xrightarrow{h[1]} & X_U[1] & \longrightarrow & U'[1] \end{array}$$

Now, since $\text{Hom}_{\mathcal{C}}(T, T[1]) = 0$ there exist a morphism $c : U' \rightarrow T[1]$ such that $h = cg$. Then we have

$$h[1](cg) = (h[1] \circ c)g = 0,$$

since $(h[1] \circ c) \in \text{Hom}_{\mathcal{C}}(U', X_U[1]) = 0$. Hence $\text{Hom}_{\mathcal{C}}(X_U, X_U[1]) = 0$ as required. Thus we have shown that T_U is rigid.

(ii) Now we show that T_U is cluster-tilting in \mathcal{C} . By the bijection in Theorem 4.18, we only need to show that $\overline{T_U}$ is a support τ -tilting A -module. Since T_U is rigid, we have that $\overline{T_U}$ is τ -rigid (see Theorem 4.18). Apply the functor (17) to the triangle (19) to obtain an exact sequence

$$A \xrightarrow{\overline{g}} \overline{X_U} \rightarrow \overline{U'} \rightarrow 0.$$

We claim that \overline{g} is a left $(\text{add } \overline{T_U})$ -approximation of A . In fact, since we have $\text{Hom}_{\mathcal{C}}(U[-1], T_U) = 0$, for every morphism $h : T \rightarrow T_U$ in \mathcal{C} we obtain a commutative diagram

$$\begin{array}{ccccccc} U[-1] & \longrightarrow & T & \xrightarrow{g} & X_U & \longrightarrow & U \\ & & \searrow 0 & & \downarrow h & & \\ & & & & T_U & & \end{array}$$

Thus g is a left $(\text{add } T_U)$ -approximation of T and then by the equivalence (18) we have that \bar{g} is a left $(\text{add } \overline{T_U})$ -approximation of A . Then by Proposition 2.14 we have that $\overline{T_U}$ is a support τ -tilting A -module.

Finally, since $\text{Hom}_A(T, T[1]) = 0$ and U has no non-zero direct summands in $\text{add } T[1]$, it follows from the triangle (19) that T_U has no non-zero direct summands in $\text{add } T[1]$. \square

The following proposition relates the Bongartz completion T_U of U in \mathcal{C} with respect to T with the Bongartz completion $\overline{T_U}$ of \overline{U} in $\text{mod } A$. Recall that $T_{\overline{U}}$ is the unique maximal element in $s\tau\text{-tilt}_{\overline{U}} A$.

Proposition 4.22. *We have $\overline{T_U} \cong T_{\overline{U}}$.*

Proof. By Proposition 3.2, $P(\perp(\tau\overline{U}))$ is the unique maximal element in $s\tau\text{-tilt}_{\overline{U}} A$. Hence to show that $\overline{T_U} \cong P(\perp(\tau\overline{U}))$ we only need to show that if \overline{M} is a support τ -tilting A -module such that $\overline{U} \in \text{add } \overline{M}$, then $\overline{M} \in \text{Fac } \overline{T_U}$. By definition, this is equivalent to show that there exists an exact sequence of A -modules

$$\text{Hom}_{\mathcal{C}}(T, X) \rightarrow \text{Hom}_{\mathcal{C}}(T, M) \rightarrow 0$$

with $X \in \text{add } T_U$.

Let $f : T' \rightarrow M$ be a right $(\text{add } T)$ -approximation of M . By the definition of X_U , there exist a triangle

$$T' \xrightarrow{g} X \rightarrow U'' \rightarrow T[1]$$

where $X \in \text{add } X_U$ and $U'' \in \text{add } U$. Since $\text{Hom}_{\mathcal{C}}(U'[-1], M) = D \text{Hom}_{\mathcal{C}}(M, U'[1]) = 0$ by the 2-Calabi-Yau property of \mathcal{C} , the following diagram commutes:

$$\begin{array}{ccccc} U''[-1] & \longrightarrow & T' & \xrightarrow{g} & X & \longrightarrow & U'' \\ & \searrow 0 & \downarrow f & \swarrow h & & & \\ & & M & & & & \end{array}$$

It follows that there exist a morphism $h : X \rightarrow M$ such that $f = hg$. Now it is easy to see that the sequence

$$\text{Hom}_{\mathcal{C}}(T, X) \xrightarrow{h} \text{Hom}_{\mathcal{C}}(T, M) \rightarrow 0$$

is exact. Indeed, let $u : T \rightarrow M$. since f is a right $(\text{add } T)$ -approximation of M , there exist a morphism $v : T \rightarrow T'$ such that $u = fv$. It follows that

$$u = fv = (hg)v = h(gv).$$

This shows that u factors through h , which is what we needed to show. \square

We are ready to state the main theorem of this section. We keep the notation of the above discussion.

Theorem 4.23. *With the hypotheses of Settings 4.17 and 4.19, we have the following:*

- The algebras $\text{End}_{\mathcal{U}}(T_U)$ and $C = \text{End}_A(\overline{T_U})/\langle e_{\overline{U}} \rangle$ are isomorphic, where $e_{\overline{U}}$ is the idempotent corresponding to the projective $\text{End}_A(\overline{T_U})$ -module $\text{Hom}_A(\overline{T_U}, \overline{U})$.*
- We have a commutative diagram*

$$\begin{array}{ccc} \text{c-tilt}_U \mathcal{C} & \xrightarrow{\text{Hom}_{\mathcal{C}}(T, -)} & s\tau\text{-tilt}_{\overline{U}} A \\ \text{red} \downarrow & & \downarrow \text{red} \\ \text{c-tilt } \mathcal{U} & \xrightarrow{\text{Hom}_{\mathcal{U}}(T_U, -)} & s\tau\text{-tilt } C \end{array}$$

in which each arrow is a bijection. The vertical maps are given in Theorem 4.20 and Theorem 3.15.

We begin with the proof of part (a) of Theorem 4.23.

Lemma 4.24. *For each M in ${}^\perp(U[1])$ we have an isomorphism of vector spaces*

$$\frac{\mathrm{Hom}_A(\overline{T_U}, \overline{M})}{[\overline{U}](\overline{T_U}, \overline{M})} \cong \mathrm{Hom}_{\mathcal{U}}(T_U, M).$$

Proof. By the equivalence (18), we have the following isomorphism

$$\frac{\mathrm{Hom}_A(\overline{T_U}, \overline{M})}{[\overline{U}](\overline{T_U}, \overline{M})} \cong \frac{\frac{\mathrm{Hom}_{\mathcal{C}}(T_U, M)}{[T[1]](T_U, M)}}{\frac{[U](T_U, M) + [T[1]](T_U, M)}{[S[1]](T_U, M)}}.$$

We claim that $[T[1]](T_U, M) \subseteq [U](T_U, M)$, or equivalently $[T[1]](X_U, M) \subseteq [U](X_U, M)$ since $T_U = X_U \oplus U$. Apply the contravariant functor $\mathrm{Hom}_{\mathcal{C}}(-, T[1])$ to the triangle (19) to obtain an exact sequence

$$\mathrm{Hom}_{\mathcal{C}}(U', T[1]) \rightarrow \mathrm{Hom}_{\mathcal{C}}(X_U, T[1]) \rightarrow \mathrm{Hom}_{\mathcal{C}}(T, T[1]) = 0.$$

Hence every morphism $X_U \rightarrow T[1]$ factors through U' , and we have $[T[1]](X_U, M) \subseteq [U](X_U, M)$. Thus we have the required isomorphisms

$$\frac{\mathrm{Hom}_A(\overline{T_U}, \overline{M})}{[\overline{U}](\overline{T_U}, \overline{M})} \cong \frac{\mathrm{Hom}_{\mathcal{C}}(T_U, M)}{[U](T_U, M)} \cong \mathrm{Hom}_{\mathcal{U}}(T_U, M),$$

so the assertion follows. \square

Now part (a) of Theorem 4.23 follows by putting $M = T_U$ in Lemma 4.24. In the remainder we prove Theorem 4.23(b).

For $X \in \mathrm{mod} A$ we denote by $0 \rightarrow \mathrm{t}X \rightarrow X \rightarrow \mathrm{f}X \rightarrow 0$ the canonical sequence of X with respect to the torsion pair $(\mathrm{Fac} \overline{U}, \overline{U}^\perp)$ in $\mathrm{mod} A$.

Proposition 4.25. *For each M in ${}^\perp(U[1])$ there is an isomorphism of \mathcal{C} -modules*

$$\mathrm{Hom}_{\mathcal{U}}(T_U, M) \cong \mathrm{Hom}_A(\overline{T_U}, \mathrm{f}\overline{M}).$$

Proof. By Lemma 4.24 it is enough to show that

$$\frac{\mathrm{Hom}_A(\overline{T_U}, \overline{M})}{[\overline{U}](\overline{T_U}, \overline{M})} \cong \mathrm{Hom}_A(\overline{T_U}, \mathrm{f}\overline{M}).$$

We can proceed exactly as in the proof of Proposition 4.15. \square

We are ready to give the prove Theorem 4.23(b).

Proof of Theorem 4.23(b). Let $M \in \mathrm{c}\text{-tilt } \mathcal{C}$ be such that $U \in \mathrm{add} M$. Since τ -tilting reduction of \overline{M} is given by $F(\mathrm{f}\overline{M}) = \mathrm{Hom}_A(T_{\overline{U}}, \mathrm{f}M)$, see Theorem 3.15, we only need to show that

$$\mathrm{Hom}_{\mathcal{U}}(T_U, M) = \mathrm{Hom}_A(T_{\overline{U}}, \mathrm{f}M).$$

But this is precisely the statement of Proposition 4.25 since $\overline{T_U} \cong T_{\overline{U}}$ by Proposition 4.22. \square

We conclude this section with an example illustrating the bijections in Theorem 4.23.

Example 4.26. Let \mathcal{C} be the cluster category of type D_4 . Recall that \mathcal{C} is a 2-Calabi-Yau triangulated category, see [10]. The Auslander-Reiten quiver of \mathcal{C} is the following, where the dashed edges are to be identified to form a cylinder, see [28, 6.4]:

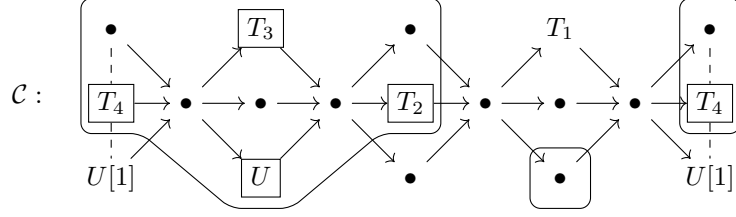

We have chosen a cluster-tilting object $T = T_1 \oplus T_2 \oplus T_3 \oplus T_4$ and a rigid indecomposable object U in \mathcal{C} . The Bongartz completion of U with respect to T is given by $T_U = U \oplus T_2 \oplus T_3 \oplus T_4$, and is indicated with squares. Also, the ten indecomposable objects of the subcategory ${}^\perp(U[1])$ have been encircled.

On the other hand, let $A = \text{End}_{\mathcal{C}}(T)$ and $\overline{(-)} = \text{Hom}_{\mathcal{C}}(T, -)$. Then A is isomorphic to algebra given by the quiver

$$Q' = \begin{array}{ccc} & 2 \xleftarrow{x_1} 1 & \\ x_2 \downarrow & & \uparrow x_4 \\ & 3 \xrightarrow{x_3} 4 & \end{array}$$

with relations $x_1x_2x_3 = 0$, $x_2x_3x_4 = 0$, $x_3x_4x_1 = 0$ and $x_4x_1x_2 = 0$. Thus A is isomorphic to the Jacobian algebra of the quiver with potential $(Q', x_1x_2x_3x_4)$. The Auslander-Reiten quiver of $\text{mod } A$ is the following:

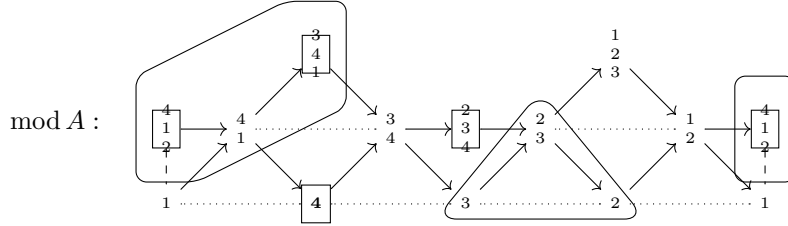

We have indicated the indecomposable direct summands of the Bongartz completion $\overline{T_U}$ of $\overline{U} = S_4$, with rectangles. The six indecomposable objects of the category ${}^\perp(\tau\overline{U}) \cap \overline{U}^\perp$ are encircled. Finally, let $C = \text{End}_A(\overline{T_U})/\langle e_{\overline{U}} \rangle$. Note that C is isomorphic by the algebra by the quiver

$$Q = \begin{array}{ccc} & 1 & \\ x_1 \swarrow & & \nwarrow x_3 \\ 2 & \xrightarrow{x_2} & 3 \end{array}$$

with relations $x_1x_2 = 0$, $x_2x_3 = 0$ and $x_3x_1 = 0$, see Example 2.19. Thus C is isomorphic to the Jacobian algebra of the quiver with potential $(Q, x_1x_2x_3)$, see [13] for definitions. By Theorem 3.8 we have that ${}^\perp(\tau\overline{U}) \cap \overline{U}^\perp$ is equivalent to $\text{mod } C$. The Auslander-Reiten quiver of $\text{mod } C$ is the following, where each C -module is represented by its radical filtration:

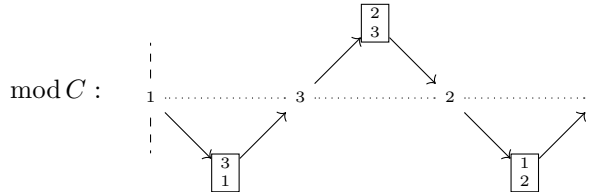

On the other hand, let $\mathcal{U} = {}^\perp(U[1])/[U]$. The Auslander-Reiten quiver of \mathcal{U} is the following, note that the dashed edges are to be identified to form a Möbius strip:

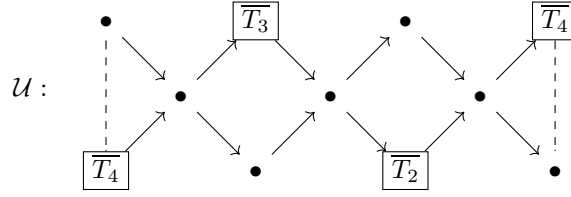

Observe that \mathcal{U} is equivalent to the cluster category of type A_3 . Moreover, by Theorem 4.23(a) we have an isomorphism between $\text{End}_{\mathcal{U}}(T_U)$ and C . By Theorem 4.23(b) we have a commutative diagram

$$\begin{array}{ccc}
 \text{c-tilt}_{\mathcal{U}} C & \xrightarrow{\text{Hom}_C(T, -)} & \text{s}\tau\text{-tilt}_{\overline{\mathcal{U}}} A \\
 \text{red} \downarrow & & \downarrow \text{red} \\
 \text{c-tilt } \mathcal{U} & \xrightarrow{\text{Hom}_{\mathcal{U}}(T_U, -)} & \text{s}\tau\text{-tilt } C
 \end{array}$$

REFERENCES

- [1] T. Adachi, O. Iyama, and I. Reiten. τ -tilting theory. *arXiv:1210.1036 (to appear in Compos. Math.)*, Oct. 2012.
- [2] T. Aihara. Tilting-connected symmetric algebras. *Algebr Represent Theor*, 16(3):873–894, June 2013.
- [3] T. Aihara and O. Iyama. Silting mutation in triangulated categories. *J. London Math. Soc.*, 85(3):633–668, June 2012.
- [4] I. Assem, D. Simson, and A. Skowroński. *Elements of the Representation Theory of Associative Algebras*, volume 1 of *London Mathematical Society Students Texts*. Cambridge University Press, New York City, USA, 2006.
- [5] M. Auslander, M. I. Platzeck, and I. Reiten. Coxeter functors without diagrams. *Trans. Amer. Math. Soc.*, 250:146, 1979.
- [6] M. Auslander and I. Reiten. Applications of contravariantly finite subcategories. *Adv. Math.*, 86(1):111–152, Mar. 1991.
- [7] M. Auslander and S. O. Smalø. Almost split sequences in subcategories. *J. Algebra*, 69(2):426–454, Apr. 1981.
- [8] I. N. Bernšteĭn, I. M. Gel’fand, and V. A. Ponomarev. Coxeter functors, and Gabriel’s theorem. *Uspehi Mat. Nauk*, 28(2(170)):19–33, 1973.
- [9] T. Brüstle and D. Yang. Ordered exchange graphs. *arXiv:1302.6045*, Feb. 2013.
- [10] A. B. Buan, R. Marsh, M. Reineke, I. Reiten, and G. Todorov. Tilting theory and cluster combinatorics. *Adv. Math.*, 204(2):572–618, Aug. 2006.
- [11] A. B. Buan, R. Marsh, and I. Reiten. Cluster-tilted algebras. *Trans. Amer. Math. Soc.*, 359(1):323–332, 2007.
- [12] H. Derksen and J. Fei. General presentations of algebras. *arXiv:0911.4913*, Nov. 2009.
- [13] H. Derksen, J. Weyman, and A. Zelevinsky. Quivers with potentials and their representations I: Mutations. *Selecta Math.*, 14(1):59–119, Oct. 2008.
- [14] W. Geigle and H. Lenzing. Perpendicular categories with applications to representations and sheaves. *J. Algebra*, 144(2):273–343, Dec. 1991.
- [15] C. Geiß, B. Leclerc, and J. Schröer. Rigid modules over preprojective algebras. *Invent. Math.*, 165(3):589–632, Sept. 2006.
- [16] D. Happel and L. Unger. On a partial order of tilting modules. *Algebr. Represent. Theory*, 8(2):147–156, 2005.
- [17] D. Happel and L. Unger. Links of faithful partial tilting modules. *Algebr Represent Theor*, 13(6):637–652, Dec. 2010.
- [18] C. Ingalls and H. Thomas. Noncrossing partitions and representations of quivers. *Compositio Math.*, 145(06):1533–1562, 2009.
- [19] O. Iyama, P. Jorgensen, and D. Yang. Intermediate co-t-structures, two-term silting objects, tau-tilting modules, and torsion classes. *arXiv:1311.4891*, Nov. 2013.
- [20] O. Iyama and S. Oppermann. Stable categories of higher preprojective algebras. *Advances in Mathematics*, 244:23–68, Sept. 2013.
- [21] O. Iyama and D. Yang. Silting reduction. *In preparation*, 2013.
- [22] O. Iyama and Y. Yoshino. Mutation in triangulated categories and rigid Cohen-Macaulay modules. *Invent. Math.*, 172(1):117–168, Apr. 2008.
- [23] B. Keller. Derived categories and their uses. In M. Hazewinkel, editor, *Handbook of Algebra*, volume 1, pages 671–701. North-Holland, 1996.

- [24] B. Keller and I. Reiten. Cluster-tilted algebras are gorenstein and stably CalabiYau. *Adv. Math.*, 211(1):123–151, May 2007.
- [25] D. Quillen. Higher algebraic K -theory. I. In *Algebraic K-theory, I: Higher K-theories (Proc. Conf., Battelle Memorial Inst., Seattle, Wash., 1972)*, number 341 in Lecture Notes in Math., pages 85–147. Springer, Berlin, 1973.
- [26] C. Riedtmann and A. Schofield. On a simplicial complex associated with tilting modules. *Comment. Math. Helv.*, 66:70–78, 1991.
- [27] C. M. Ringel. The self-injective cluster-tilted algebras. *Arch. Math.*, 91(3):218–225, Sept. 2008.
- [28] R. Schiffler. A geometric model for cluster categories of type D_n . *J. Algebraic Combin.*, 27(1):1–21, Feb. 2008.
- [29] J. Wei. Semi-tilting complexes. *Isr. J. Math.*, pages 1–23, 2012.

GRADUATE SCHOOL OF MATHEMATICS, NAGOYA UNIVERSITY. NAGOYA, JAPAN
E-mail address: jasso.ahuja.gustavo@b.mbox.nagoya-u.ac.jp